

**CASE 056-S-22**  
*PRELIMINARY MEMORANDUM*  
July 5, 2022

**Petitioners:** Bill Cope and Mary Kalantzis, d.b.a. Prairie Glass House, LLC

**Request:** Authorize the expansion of the Special Use Permit approved in Case 935-S-19 for a combination “Private Indoor Recreational Development” and “Outdoor Commercial Recreational Enterprise” to include a proposed detached accessory pavilion on land in the AG-2 Agriculture Zoning District.

**Location:** A 17.2 acre tract that is approximately in the East Half of the Northeast Quarter of the Northwest Quarter of Section 32, Township 20 North, Range 9 East of the Third Principal Meridian in Somer Township, and commonly known as the residence at 4018 North Lincoln Avenue, Champaign.

**Site Area:** 17.2 acres

**Time Schedule for Development:** As soon as possible

**Prepared by:** **Susan Burgstrom**  
Senior Planner

**John Hall**  
Zoning Administrator

---

**BACKGROUND**

The petitioners have a Special Use Permit for an event center in the AG-2 Agriculture portion of their 17.2 acre property that was approved on October 24, 2019. Their most recent events were held in the house and on the grounds. The petitioners would like to build an enclosed pavilion to hold events and this requires an expansion of the Special Use Permit approved in case 935-S-19. They propose a maximum of 150 guests, and only one event would occur at a time.

The proposed pavilion would be located in a Special Flood Hazard Area, so a Floodplain Development Permit will be required in addition to a standard building permit. This extra permit process will ensure that the building will not impact the Saline Branch that runs through the property.

**EXISTING LAND USE AND ZONING**

**Table 1. Land Use and Zoning in the Vicinity**

<b>Direction</b>	<b>Land Use</b>	<b>Zoning</b>
Onsite	Residential and Event Center	CR Conservation Recreation AG-2 Agriculture
North	Agriculture and Residential	CR Conservation Recreation (east of Lincoln Ave) AG-2 Agriculture (west of Lincoln Ave)
East	Agriculture and Residential	CR Conservation Recreation
West	Agriculture	CR Conservation Recreation AG-2 Agriculture
South	Agriculture	CR Conservation Recreation

## **EXTRATERRITORIAL JURISDICTION**

The subject property is within the one and one-half mile extraterritorial jurisdiction of the City of Urbana, a municipality with zoning. Zoned municipalities do not have protest rights in Special Use Permit cases, but notice of the public hearing was sent to the City.

The subject property is located within Somer Township, which does not have a Planning Commission.

## **OUTSTANDING SPECIAL CONDITIONS FROM CASE 935-S-19**

The Special Use Permit approved in case 935-S-19 had special conditions for screening from an adjacent residential lot within six months and for installing a septic system within one year of approval of the case. Shortly after approval, COVID-19 stalled all events and everything was put on hold. Those special conditions have been added to the current Special Use Permit expansion request with the same timeline for completion.

## **PROPOSED SPECIAL CONDITIONS**

- A. **The Zoning Administrator shall not issue a Zoning Compliance Certificate for the proposed expansion to the Private Indoor Recreational Development/Outdoor Commercial Recreational Enterprise until the petitioner has demonstrated that the proposed Special Use complies with the Illinois Accessibility Code.**

The special condition stated above is required to ensure the following:

**That the proposed Special Use meets applicable State requirements for accessibility.**

- B. **The Zoning Administrator shall not authorize a Zoning Use Permit Application or issue a Zoning Compliance Certificate on the subject property until the lighting specifications in Paragraph 6.1.2.A. of the Zoning Ordinance have been met.**

The special condition stated above is required to ensure the following:

**That exterior lighting meets the requirements established for Special Uses in the Zoning Ordinance.**

- C. **All onsite Special Use activities shall be in compliance at all times with the Champaign County Health Ordinance, the Champaign County Liquor Ordinance, and the Champaign County Recreation and Entertainment Ordinance.**

The special condition stated above is required to ensure the following:

**That the proposed Special Use is in ongoing compliance with all applicable County requirements.**

- D. **The Petitioner shall ensure that the guests are made aware of the County Ordinance prohibiting nuisance noise past 10 pm and that the use of the facility requires compliance to avoid complaints from neighboring residences. Music and other nuisance noise shall not be audible at the property line past 10 pm.**

---

The special condition stated above is required to ensure the following:

**That events held on the subject property adequately consider neighbors.**

- E. **This special use permit does not authorize onsite food preparation or the construction of any food preparation area or kitchen.**

The special condition stated above is required to ensure the following:

**To protect public health.**

- F. **Within one year of approval of zoning case 056-S-22, the petitioners shall install a new septic system as approved by the Champaign County Health Department. If the septic system is not installed and approved by the Health Department within one year, the Special Use Permit shall be suspended until the septic system has been installed and approved by the Health Department, and the following documentation shall be submitted to the Zoning Administrator:**

(1) **A true and correct copy of an approved COUNTY Health Department PERMIT for construction of the private sewage disposal system.**

(2) **A true and correct copy of the COUNTY Health Department Certificate of Approval for the private sewage disposal system shall be submitted to the Zoning Administrator prior to the use of any new septic system.**

The special condition stated above is required to ensure the following:

**Any new septic system is in compliance with the Champaign County Zoning Ordinance.**

- G. **This Special Use Permit shall expire if no events are held during any consecutive 365-day period.**

The special condition stated above is required to ensure the following:

**To provide both a sense of continuity and a sense of closure to the neighbors.**

- H. **Within six months of approval of Zoning Cases 056-S-22, the petitioner shall install a Type A screen along the petitioner's side of the shared property lines of the adjacent residence to the north with an address of 4102 N Lincoln Avenue, Champaign.**

The special condition stated above is required to ensure the following:

**That the event center parking area complies with Section 7.4.1.C.4. of the Zoning Ordinance.**

- I. **No building construction is permitted in proposed Outlot 1.**

The special condition stated above is required to ensure the following:

**That no event center construction occurs in the CR Conservation Recreation Zoning District.**

## **ATTACHMENTS**

- A Case Maps (Location, Land Use, Zoning)
- B Proposed Site Plan received May 18, 2022
- C Preliminary Plat by Berns, Clancy & Associates received May 18, 2022
- D Site Visit Photos taken April 9, 2019 (from previous case 935-S-19)
- E Draft Summary of Evidence, Finding of Fact and Final Determination for Case 056-S-22 dated July 14, 2022

# Location Map

Case 056-S-22  
July 14, 2022

Subject Property

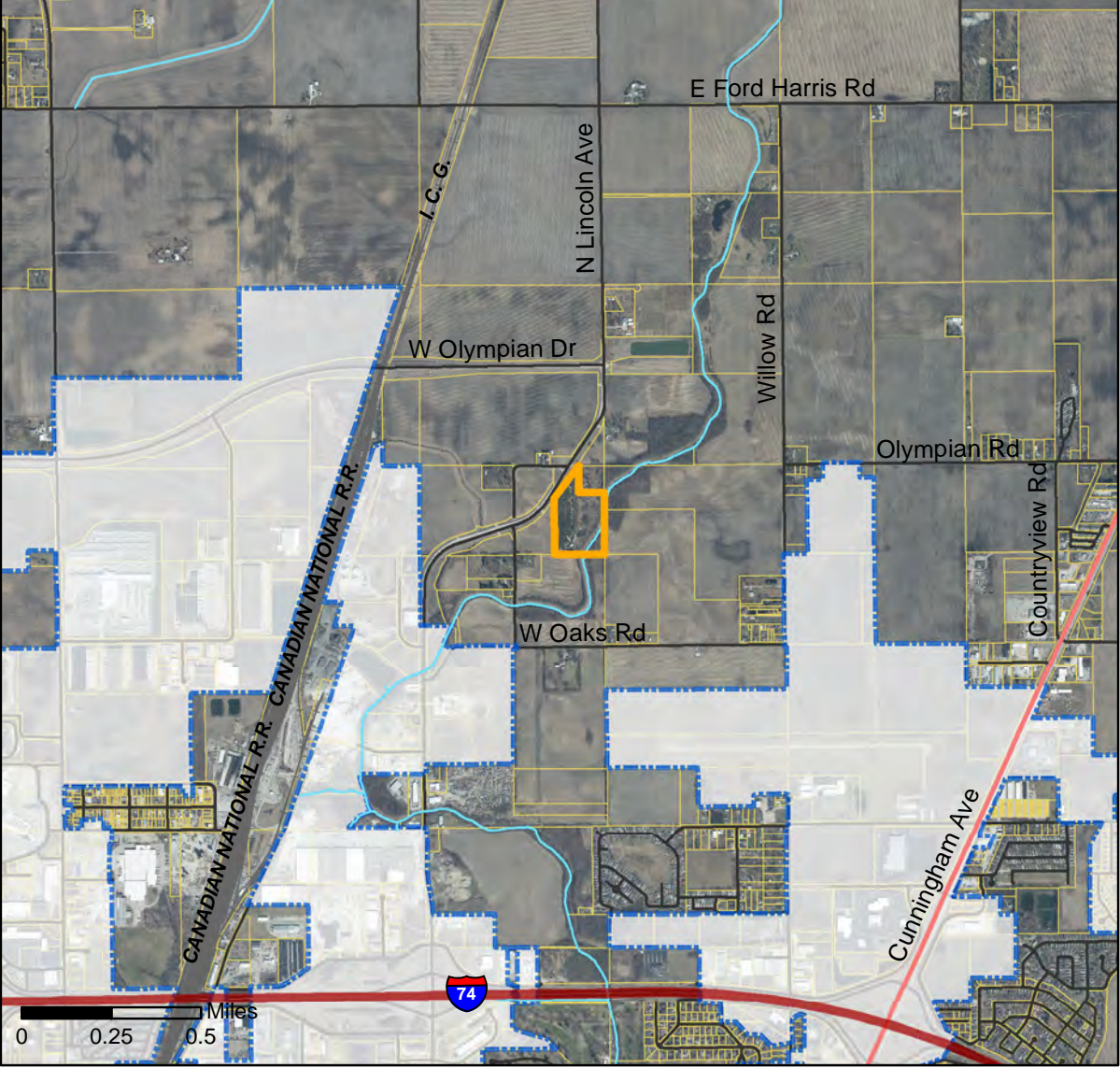

Property location in Champaign County

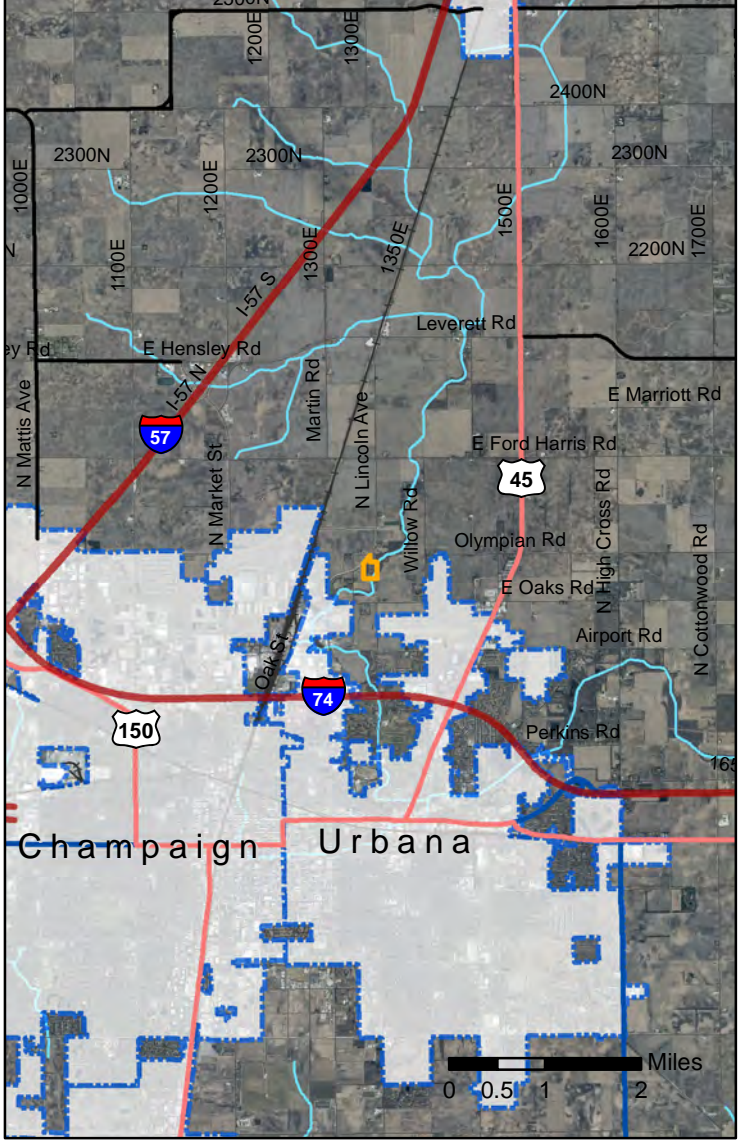

- Subject Property
- Municipal Boundary
- Streets
- Railroads
- Parcels



Champaign County  
Department of  
**PLANNING &  
ZONING**

# Land Use Map

Case 056-S-22  
July 14, 2022

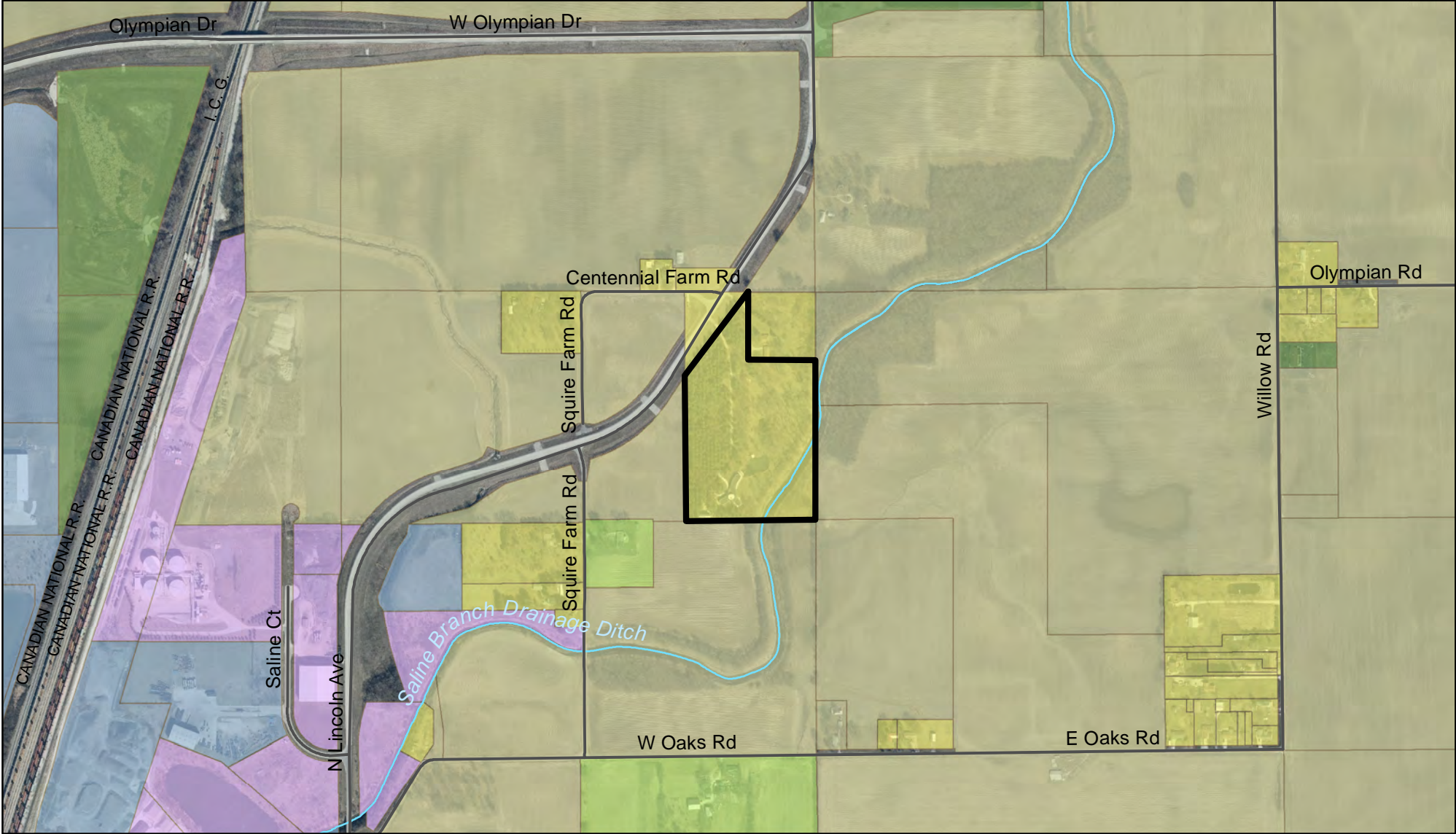

- Subject Property
- Residential
- Agriculture
- Commercial
- Ag/Residential
- Industrial
- Tax Exempt

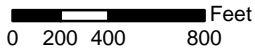

Champaign County  
Department of  
**PLANNING &  
ZONING**

# Zoning Map

Case 056-S-22  
July 14, 2022

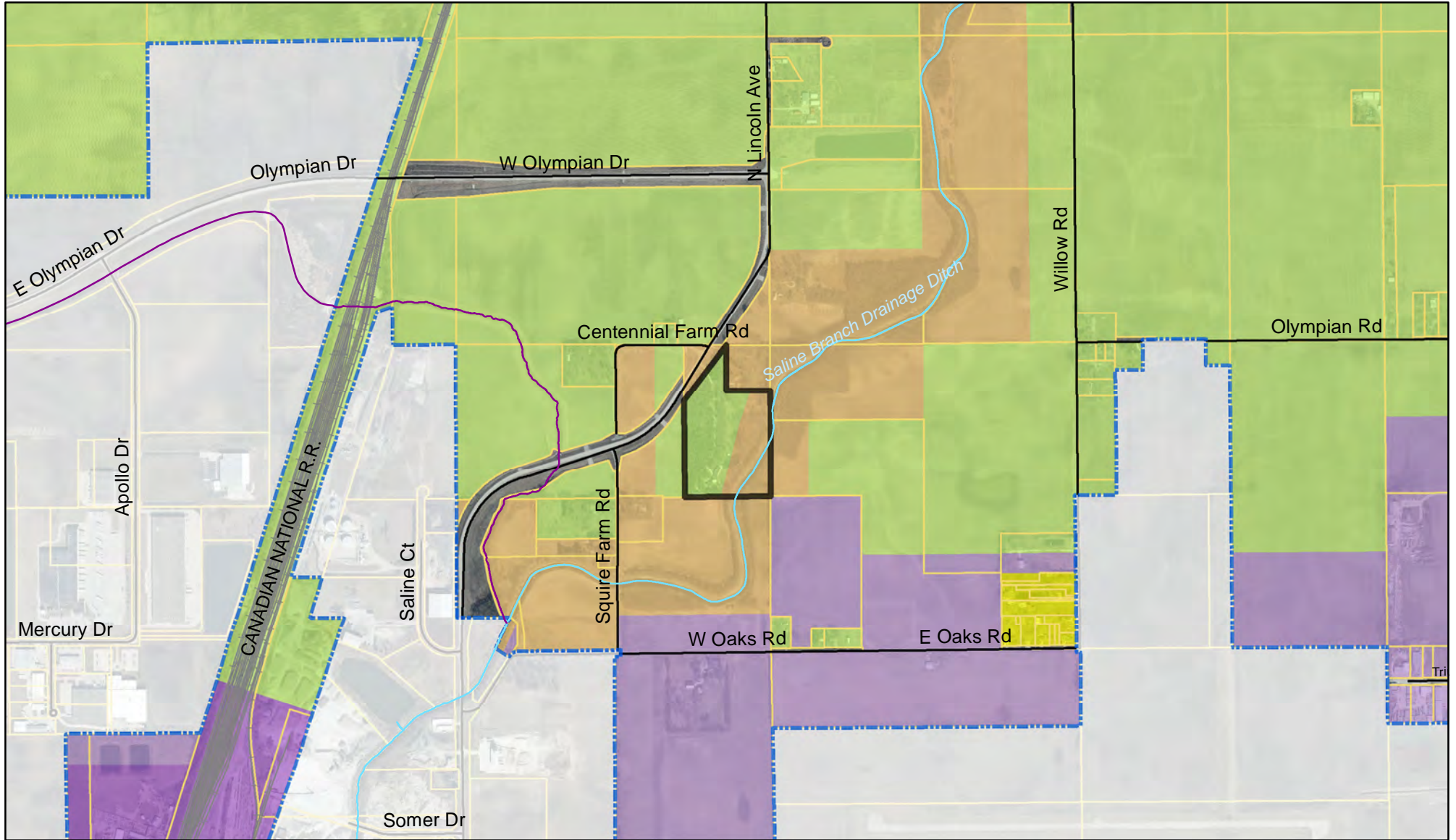

- Subject Property
- Municipal Boundary
- Parcels
- AG-2 Agriculture
- CR Conservation Recreation
- I-1 Light Industry
- I-2 Heavy Industry
- R-2 Single Family Residence

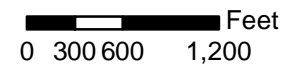

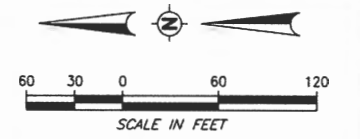
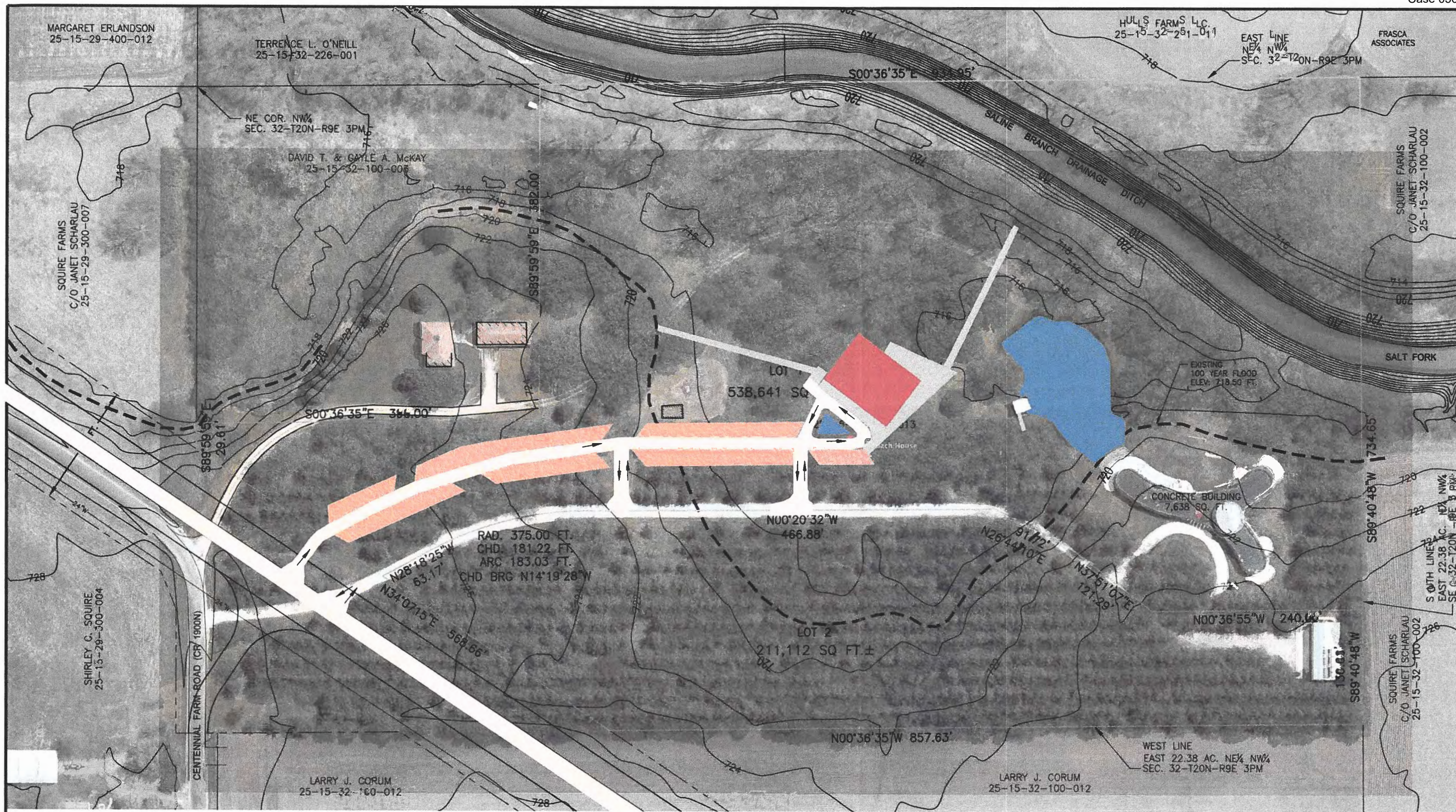

- LEGEND**
- 100' LINE
  - EXISTING 100 YEAR FLOOD ELEVATION: 718.50 FT.
  - EXISTING BUILDING LINE
  - 750' EXISTING INDEX CONTOUR LINE
  - 749' EXISTING INTERMEDIATE CONTOUR LINE
  - PROPOSED CENTERLINE
  - PROPOSED RIGHT-OF-WAY LINE
  - PROPOSED LOT LINE

**RECEIVED**  
 MAY 18 2022  
 CHAMPAIGN CO. P & Z DEPARTMENT

CONTOUR DATA FROM  
 CHAMPAIGN COUNTY LIDAR  
 DATED 2005

AERIAL PHOTOGRAPHY FROM  
 CHAMPAIGN COUNTY  
 ORTHOPHOGRAPHY  
 DATED APRIL 2011

# Kalantzis/Cope Pavilion

Jeffery Poss Architect, PLLC 05.17.22

**LOT SIZE SUMMARY**

LOT 1:	538,641 SQ FT.±
LOT 2:	211,112 SQ FT.±

- Notes:
- 45 degree angle parking is shown for 55 spaces, in beige. The angled parking minimizes the width of the parking strip, indicated here at 45' wide. Overflow parking would remain in the same zone that already exists.
  - Pavilion is shown at 60' wide and 90' long, 5400 s.f., in salmon
  - Decks and boardwalks are indicated in grey
  - The pavilion and deck would be built of columns above the flood line. The boardwalks extend to the flood limits. The only graded portion would be the circular drop-off ramp. The fill to build this ramp would be used to create a fountain in the middle of the drop-off, minimizing grading equipment. Accessible parking is along the west side of the drop-off ramp.

**KALANTZIS/COPE FIRST SUBDIVISION  
 KALANTZIS/COPE RESORT  
 PART OF THE NORTHEAST QUARTER  
 OF THE NORTHWEST QUARTER  
 OF SECTION 32, TOWNSHIP 20 NORTH,  
 RANGE 9 EAST OF THE THIRD  
 PRINCIPAL MERIDIAN. SOMER TOWNSHIP  
 CHAMPAIGN COUNTY, ILLINOIS**

100 YEAR BASE FLOOD ELEVATION 718.50 FEET  
 REPORTED SALT FORK OF THE VERMILION RIVER  
 HYDROLOGIC MODEL BY KARL K. VISSER  
 FOR THE CHAMPAIGN COUNTY SOIL AND  
 WATER CONSERVATION DISTRICT AND THE  
 SALT FORK WATERSHED STEERING COMMITTEE  
 DATED JANUARY 16, 2003

**BERNS, CLANCY AND ASSOCIATES**  
 ENGINEERS • SURVEYORS • PLANNERS  
 405 EAST MAIN STREET - POST OFFICE BOX 755  
 URBANA, ILLINOIS 61803-0755  
 PHONE (217) 384-1144 - FAX: (217) 384-3355

**BCA**

JOB: 5730-5      DATE: 081321  
 FILE: 5730-5.DWG      SHEET 2 OF 2



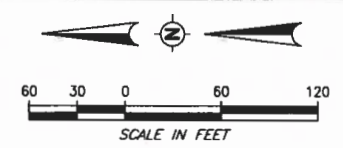
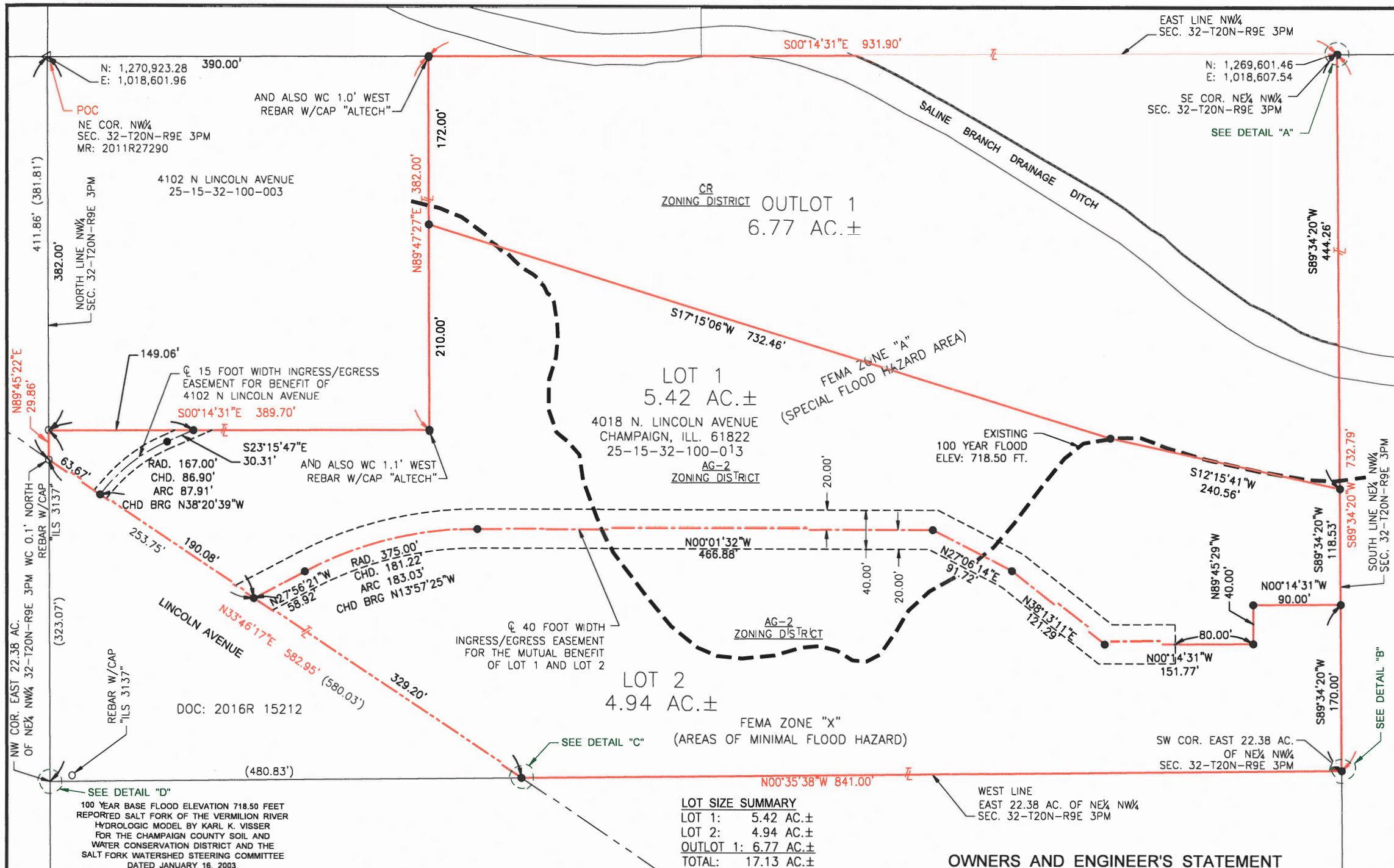

- LEGEND**
- 30 INCH LONG, 1/2 INCH DIAMETER IRON PIPE SURVEY MONUMENT SET WITH ALUMINUM CAP STAMPED "ILS 2207"
  - EXISTING IRON PIPE/PIN SURVEY MONUMENT FOUND
  - △ STONE SURVEY MONUMENT FOUND
  - TITLE LINE
  - - - EXISTING 100 YEAR FLOOD ELEVATION: 718.50 FT.
  - - - EXISTING RIGHT-OF-WAY LINE
  - PROPOSED LOT LINE
  - - - PROPOSED EASEMENT LINE
  - - - PROPOSED CENTERLINE
  - WC WITNESS CORNER

TOWNSHIP HIGHWAY COMMISSIONER

I, RICK WOLKEN, TOWNSHIP HIGHWAY COMMISSIONER OF SOMER TOWNSHIP DO HEREBY CERTIFY THAT THIS PLAT HAS BEEN REVIEWED BY ME AND APPROVED WITH RESPECT TO ROADWAY ACCESS AND OTHER MATTERS UNDER MY JURISDICTION.

DATED THIS \_\_\_\_\_ DAY OF \_\_\_\_\_ A.D., 20\_\_\_\_

\_\_\_\_\_  
TOWNSHIP HIGHWAY COMMISSIONER

APPROVED BY:

\_\_\_\_\_  
CITY ENGINEER

\_\_\_\_\_  
DIRECTOR, COMMUNITY DEVELOPMENT SERVICES

\_\_\_\_\_  
SECRETARY, URBANA PLAN COMMISSION

DATE: \_\_\_\_\_

ATTEST: \_\_\_\_\_, CITY CLERK \_\_\_\_\_ DATE \_\_\_\_\_

**OWNERS AND ENGINEER'S STATEMENT**

TO THE BEST OF OUR KNOWLEDGE AND BELIEF, THE DRAINAGE OF SURFACE WATERS WILL NOT BE CHANGED BY THE DEVELOPMENT OF "KALANTZIS/COPE FIRST SUBDIVISION, SOMER TOWNSHIP, CHAMPAIGN COUNTY, ILLINOIS", OR ANY PART THEREOF, OR IF SUCH SURFACE WATER DRAINAGE WILL BE CHANGED THAT REASONABLE PROVISION HAS BEEN MADE FOR THE COLLECTION AND DIVERSION OF SURFACE WATERS INTO PUBLIC AREAS, OR DRAINS WHICH THE SUBDIVIDER HAS THE RIGHT TO USE, AND THAT SUCH SURFACE WATERS WILL BE PLANNED FOR IN ACCORDANCE WITH GENERALLY ACCEPTED ENGINEERING PRACTICES SO AS TO REDUCE THE LIKELIHOOD OF DAMAGE TO THE ADJOINING PROPERTY BECAUSE OF CONSTRUCTION OF "KALANTZIS/COPE FIRST SUBDIVISION, SOMER TOWNSHIP, CHAMPAIGN COUNTY, ILLINOIS".

**SIDEWALK CONSTRUCTION DEFERRAL COVENANT:**

THE DEVELOPER OR SUBSEQUENT OWNER(S) OF THE PROPERTY AFFECTED WILL CONSTRUCT THE SIDEWALK ALONG THE EASTERN RIGHT-OF-WAY OF LINCOLN AVENUE FOR 583 LINEAL FEET, AT THE DEVELOPER'S OR SUBSEQUENT OWNER'S EXPENSE WITHIN SIX (6) MONTHS OF PASSAGE OF A CITY COUNCIL RESOLUTION TO DO SO OR THE CITY WILL CONSTRUCT AND CHARGE THE THEN OWNERS AND/OR THE DEVELOPER AS APPLICABLE. CONSTRUCTION STANDARDS AND DIMENSIONS MUST COMPLY WITH THE URBANA SUBDIVISION AND LAND DEVELOPMENT CODE AND MANUAL OF PRACTICE, AS AMENDED FROM TIME TO TIME.

"IF THE DEVELOPER DOES NOT INSTALL OR PAY FOR THE INSTALLATION OF SIDEWALKS, THEN THE CITY OF URBANA HAS THE AUTHORITY TO REQUEST THE PROPERTY OWNERS TO INSTALL SIDEWALKS ON THE SUBJECT PROPERTY WITHIN SIX (6) MONTHS OF PASSAGE BY THE CITY COUNCIL OF URBANA OF A RESOLUTION TO DO SO. THE CITY HAS THE AUTHORITY TO CONSTRUCT THE SIDEWALKS AND CHARGE THE THEN OWNERS FOR THE CONSTRUCTION IF THE THEN OWNERS DO NOT INSTALL THE SIDEWALKS AS REQUESTED. IT IS AGREED BY THE DEVELOPER THAT THIS OBLIGATION SHALL BE A COVENANT RUNNING WITH THE LAND."

**NOTE:**  
SUBJECT SITE CURRENTLY HAS A JOINT DOMESTIC WATER WELL AND A JOINT PRIVATE ON-SITE SEWAGE DISPOSAL SYSTEM. A 40 FOOT BY 90 FOOT AREA AT THE SOUTHEAST CORNER OF LOT 2 SHALL BE RESERVED FOR A FUTURE PRIVATE ON-SITE SEWAGE DISPOSAL SYSTEM FOR LOT 2. LOT 1 SHALL THEN BE SERVED BY EXISTING PRIVATE ON-SITE SEWAGE DISPOSAL SYSTEM.

I, EDWARD L. CLANCY, ILLINOIS PROFESSIONAL LAND SURVEYOR 2207, IN ACCORDANCE WITH PAB-0705 (THE PLAT ACT) DO HEREBY DESIGNATE CITY OF URBANA AS THE AGENT WHO MAY RECORD "KALANTZIS/COPE FIRST SUBDIVISION, SOMER TOWNSHIP, CHAMPAIGN COUNTY, ILLINOIS", A TRUE COPY OF WHICH HAS BEEN RETAINED BY ME TO ASSURE NO CHANGES HAVE BEEN MADE TO SAID PLAT.

RETURN TO: BERNS, CLANCY AND ASSOCIATES, P.C.

EDWARD L. CLANCY, P.E., L.S., PRESIDENT  
BERNS, CLANCY AND ASSOCIATES, P.C.  
ILLINOIS PROFESSIONAL ENGINEER 31344  
LICENSE EXPIRATION: NOVEMBER 30, 2023  
URBANA, CHAMPAIGN COUNTY, ILLINOIS  
ILLINOIS PROFESSIONAL DESIGN FIRM 2999  
LICENSE EXPIRATION: APRIL 30, 2023



WILLIAM COPE  
4018 N LINCOLN AVENUE  
CHAMPAIGN, ILLINOIS 61822

**RECEIVED**

MAY 18 2022

CHAMPAIGN CO. P & Z DEPARTMENT

MARY KALANTZIS  
4018 N LINCOLN AVENUE  
CHAMPAIGN, ILLINOIS 61822

**PRELIMINARY**

EDWARD L. CLANCY, L.S., P.E., PRESIDENT  
BERNS, CLANCY AND ASSOCIATES, P.C.  
ILLINOIS PROFESSIONAL LAND SURVEYOR 2207  
LICENSE EXPIRATION: NOVEMBER 30, 2022  
URBANA, CHAMPAIGN COUNTY, ILLINOIS  
ILLINOIS PROFESSIONAL DESIGN FIRM 2999  
LICENSE EXPIRATION: APRIL 30, 2023



KALANTZIS/COPE FIRST SUBDIVISION  
PART OF THE NORTHEAST QUARTER  
OF THE NORTHWEST QUARTER  
OF SECTION 32, TOWNSHIP 20 NORTH,  
RANGE 9 EAST OF THE THIRD PRINCIPAL  
MERIDIAN. SOMER TOWNSHIP  
CHAMPAIGN COUNTY, ILLINOIS



**BERNS, CLANCY AND ASSOCIATES**  
ENGINEERS • SURVEYORS • PLANNERS  
405 EAST MAIN STREET - POST OFFICE BOX 755  
URBANA, ILLINOIS 61803-0755  
PHONE: (217) 384-1144 - FAX: (217) 384-3355

**GENERAL NOTES**

ALL MEASUREMENTS ARE IN FEET AND DECIMAL PARTS THEREOF, UNLESS NOTED OTHERWISE.

SEE CHAMPAIGN COUNTY ORDINANCES AND REGULATIONS FOR ZONING, SETBACK AND BUILDING STANDARD REQUIREMENTS.

ALL SURFACE, SUBSURFACE, BUILDING IMPROVEMENTS AND UTILITY SERVICE LINES ON AND ADJACENT TO THE SITE ARE NOT NECESSARILY SHOWN.

NAMES OF ANY APPARENT ADJOINING LAND OWNERS ARE NOT NECESSARILY SHOWN.

COORDINATES AND BEARINGS SHOWN ARE BASED UPON THE ILLINOIS STATE PLANE COORDINATE SYSTEM, EAST ZONE, NAD 83 (1986).

SEE MONUMENT RECORDS ON FILE WITH THE COUNTY RECORDER'S OFFICE FOR DETAILS OF SECTION CORNERS USED IN THIS SURVEY.

THE CHAMPAIGN COUNTY PUBLIC HEALTH DEPARTMENT STATED THE PROPOSED LOT 1 HAS AN EXISTING RESIDENTIAL HOUSE AND AN EXISTING SEPTIC TANK AND SOIL ABSORPTION FIELD. A SOIL SCIENTIST REPORT AND AN APPLICATION FOR PLAT REVIEW BY THE CHAMPAIGN COUNTY PUBLIC HEALTH DEPARTMENT IS NOT REQUIRED.

DETAILS NOT DRAWN TO SCALE.

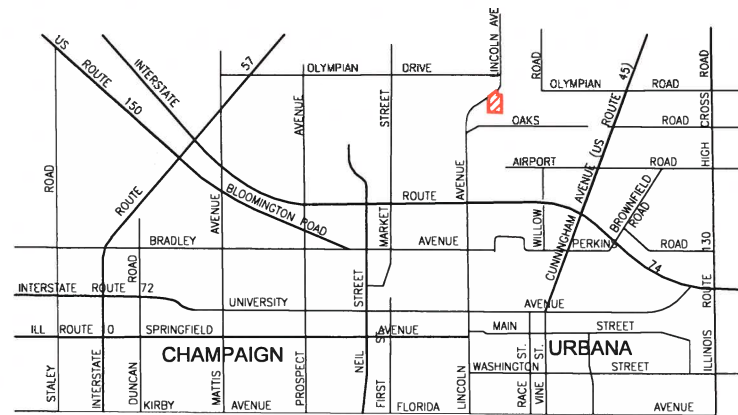

PROJECT LOCATION NO SCALE  
CHAMPAIGN - URBANA, ILLINOIS

**ZONING NOTES**

THE CHAMPAIGN COUNTY DEPARTMENT OF PLANNING AND ZONING REPORTS THAT LOT 1 AND LOT 2 ARE ZONED "AG-2" (AGRICULTURE) WITH THE FOLLOWING REQUIREMENTS:

MINIMUM LOT SIZE: 30,000 SQUARE FEET (EXCLUSIVE OF THE ROAD RIGHT OF WAY); MAXIMUM LOT SIZE: 3 ACRES; MINIMUM LOT WIDTH: 150 FEET; MINIMUM SIDE AND REAR YARDS FOR DETACHED ACCESSORY BUILDINGS IS 10 FEET. DWELLING SETBACK FROM STREET CENTERLINE (COUNTY ROAD 1800 EAST (LINCOLN AVENUE) CLASSIFIED AS MINOR ARTERIAL PER CITY OF URBANA): FRONT: 55 FEET; SIDE: 10 FEET; REAR: 20 FEET.

AND OUTLOT 1 IS ZONED "CR" (CONSERVATION RECREATION) WITH THE FOLLOWING REQUIREMENTS:

MINIMUM LOT SIZE: 1 ACRE; MINIMUM LOT WIDTH: 200 FEET; MAXIMUM BUILDING HEIGHT: 35 FEET. DWELLING SETBACK FROM STREET CENTERLINE (COUNTY ROAD 1800 EAST (LINCOLN AVENUE) CLASSIFIED AS MINOR ARTERIAL PER CITY OF URBANA): FRONT: 55 FEET; SIDE: 15 FEET; REAR: 25 FEET.

**SURVEYOR'S REPORT**

I, EDWARD L. CLANCY, ILLINOIS PROFESSIONAL LAND SURVEYOR 2207 AND PRESIDENT OF BERN, CLANCY AND ASSOCIATES, P.C. DO HEREBY STATE THAT AT THE REQUEST OF AND FOR THE EXCLUSIVE BENEFIT OF MARY KALANTZIS AND WILLIAM COPE, I PREPARED A BOUNDARY SURVEY ON THE GROUND TO THE NORMAL STANDARD OF CARE OF PROFESSIONAL LAND SURVEYORS PRACTICING IN CHAMPAIGN COUNTY, ILLINOIS PART OF THE NORTHEAST QUARTER (1/4) OF THE NORTHWEST QUARTER (1/4) OF SECTION THIRTY-TWO (32), TOWNSHIP TWENTY (20) NORTH, RANGE NINE (9) EAST OF THE THIRD PRINCIPAL MERIDIAN, CHAMPAIGN COUNTY, ILLINOIS, BEING MORE PARTICULARLY DESCRIBED AS FOLLOWS:

THE EAST 22.38 ACRES OF THE NORTHEAST 1/4 OF THE NORTHWEST 1/4 OF SECTION 32, TOWNSHIP 20 NORTH RANGE, 9 EAST OF THE THIRD PRINCIPAL MERIDIAN IN CHAMPAIGN COUNTY, ILLINOIS,

EXCEPT THE NORTH 390 FEET OF THE EAST 382 FEET, THEREOF; CONTAINING 18.96 ACRES, MORE OR LESS.

AND ALSO EXCEPT THE AREA DESCRIBED AS COMMENCING AT A STONE MONUMENT FOUND AT THE NORTHEAST CORNER OF THE NORTHWEST QUARTER OF SECTION 32, TOWNSHIP 20 NORTH, RANGE 9 EAST OF THE THIRD PRINCIPAL MERIDIAN, CHAMPAIGN COUNTY, ILLINOIS; THENCE ALONG THE NORTH LINE OF SAID SECTION 32, SOUTH 89 DEGREES 38 MINUTES 52 SECONDS WEST 381.81 FEET, TO THE POINT OF BEGINNING; THENCE SOUTH 33 DEGREES 39 MINUTES 18 SECONDS WEST 580.03 FEET, TO A POINT ON THE WEST LINE OF THE EAST 22.38 ACRES OF THE NORTHEAST QUARTER OF THE NORTHWEST QUARTER OF SAID SECTION 32; THENCE ALONG SAID WEST LINE OF THE EAST 22.38 ACRES, NORTH 0 DEGREES 11 MINUTES 33 SECONDS WEST 480.83 FEET, TO A POINT ON SAID NORTH LINE OF SECTION 32; THENCE ALONG SAID NORTH LINE OF SECTION 32, NORTH 89 DEGREES 38 MINUTES 52 SECONDS EAST 323.07 FEET, TO THE POINT OF BEGINNING, CONTAINING 1.783 ACRES, ALL IN CHAMPAIGN COUNTY, ILLINOIS.

I FURTHER STATE THAT AS A RESULT OF THIS SURVEY, THE ABOVE DESCRIBED NET TRACT CONTAINS 17.13 ACRES, MORE OR LESS, ALL AS SHOWN ON THE ACCOMPANYING PLAT OF SURVEY, ALL SITUATED IN URBANA TOWNSHIP, CHAMPAIGN COUNTY, ILLINOIS.

I FURTHER STATE THAT BASED UPON MY REVIEW OF THE FEDERAL EMERGENCY MANAGEMENT AGENCY FLOOD INSURANCE RATE MAP, COMMUNITY MAP NUMBERS 17019C0314D AND 17019C0325D WITH AN EFFECTIVE DATE OF OCTOBER 2, 2013, PART OF THE PROPERTY SURVEYED IS REPORTEDLY LOCATED WITHIN ZONE X (AREAS OF MINIMAL FLOOD HAZARD) AND PART OF THE PROPERTY SURVEYED IS REPORTEDLY LOCATED WITHIN ZONE A (SPECIAL FLOOD HAZARD AREA).

I FURTHER STATE THAT NO INVESTIGATION CONCERNING ENVIRONMENTAL AND SUBSURFACE CONDITIONS, OR TO DETERMINE THE EXISTENCE OF UNDERGROUND OR OVERHEAD CONTAINERS OR FACILITIES WHICH MAY AFFECT THE USE OR DEVELOPMENT OF THIS PROPERTY WAS MADE AS A PART OF THIS SURVEY.

I FURTHER STATE THAT THE OWNER DESIRES TO FACILITATE THE SALE OF SAID LAND BY CREATING A LOT FOR WHICH PURPOSE I PREPARED A PLAT TO WHICH THIS REPORT IS ATTACHED AND MADE A PART THEREOF, PARTICULARLY DESCRIBING AND SETTING FORTH THE LOTS INTO WHICH SAID LAND HAS BEEN SO PLATTED AND I NUMBERED THE LOTS, WHICH NUMBERS ARE SHOWN IN LARGE SIZE ON SAID PLAT AND HAVE STATED AND SHOWN THE PRECISE DIMENSIONS ON SAID LOTS.

I FURTHER STATE THAT NO INDEPENDENT INVESTIGATION CONCERNING ZONING OR LAND USE, OR INDEPENDENT SEARCH OF THE RECORDS FOR EASEMENTS, ENCUMBRANCES, RESTRICTIVE COVENANTS, SUBDIVISION RESTRICTIONS, OWNERSHIP, TITLE EVIDENCE OR ANY OTHER FACTS WHICH AN ACCURATE AND CURRENT TITLE SEARCH MAY DISCLOSE FOR SUBJECT PROPERTY OR FOR ADJOINING PARCELS WAS MADE AS A PART OF THIS SURVEY. THE SURVEYOR HAS RELIED UPON THE MATERIALS AND REPRESENTATIONS SUPPLIED BY THE CLIENT.

**SURVEYOR'S REPORT CONTINUED**

I FURTHER STATE THAT NO ATTEMPT HAS BEEN MADE AS A PART OF THIS BOUNDARY SURVEY TO OBTAIN DATA CONCERNING THE EXISTENCE, SIZE, DEPTH, CONDITION, CAPACITY, OR LOCATION OF ANY MUNICIPAL OR PUBLIC SERVICE FACILITY. FOR INFORMATION REGARDING THESE UTILITIES, PLEASE CONTACT THE APPROPRIATE AGENCIES.

I FURTHER STATE THAT I FOUND AND/OR SET THE SURVEY MONUMENTS AS SHOWN ON THE ACCOMPANYING PLAT OF SURVEY AND THERE ARE NO APPARENT ABOVE GROUND ENCROACHMENTS EXCEPT AS SHOWN ON THE ACCOMPANYING PLAT OF SURVEY.

I FURTHER STATE THAT THE ACCOMPANYING PLAT OF SURVEY IS A SCALED REPRESENTATION OF THE PHYSICAL SITUATION WHICH I FOUND IN THE FIELD AND SHOWS THE LOCATION OF VARIOUS ABOVE-GROUND FACILITIES WHICH I FOUND IN THE FIELD AT THE TIME OF MY FIELD SURVEY OF THESE PREMISES FROM OCTOBER 22, 2021 TO APRIL 5, 2022.

I FURTHER STATE THAT THE AREA COVERED BY THIS PLAT IS NOT WITHIN THE CORPORATE LIMITS OF THE CITY OF URBANA, BUT IS LOCATED WITHIN THE ONE AND ONE-HALF MILE EXTRATERRITORIAL JURISDICTIONAL LIMITS OF THE CITY OF URBANA, CHAMPAIGN COUNTY, ILLINOIS.

I FURTHER STATE AT THE REQUEST OF THE OWNER, THIS SUBDIVISION IS TO BE KNOWN AS "KALANTZIS/COPE FIRST SUBDIVISION, SOMER TOWNSHIP, CHAMPAIGN COUNTY, ILLINOIS".

I FURTHER STATE THAT THIS PROFESSIONAL SERVICE CONFORMS TO THE CURRENT ILLINOIS MINIMUM STANDARDS FOR A BOUNDARY SURVEY.

SIGNED AND SEALED MAY 11, 2022

**PRELIMINARY**

EDWARD L. CLANCY, L.S., P.E., PRESIDENT  
BERN, CLANCY AND ASSOCIATES, P.C.  
ILLINOIS PROFESSIONAL LAND SURVEYOR 2207  
LICENSE EXPIRATION: NOVEMBER 30, 2022  
URBANA, CHAMPAIGN COUNTY, ILLINOIS  
ILLINOIS PROFESSIONAL DESIGN FIRM 2999  
LICENSE EXPIRATION: APRIL 30, 2023



**RECEIVED**

MAY 18 2022

CHAMPAIGN CO. P & Z DEPARTMENT

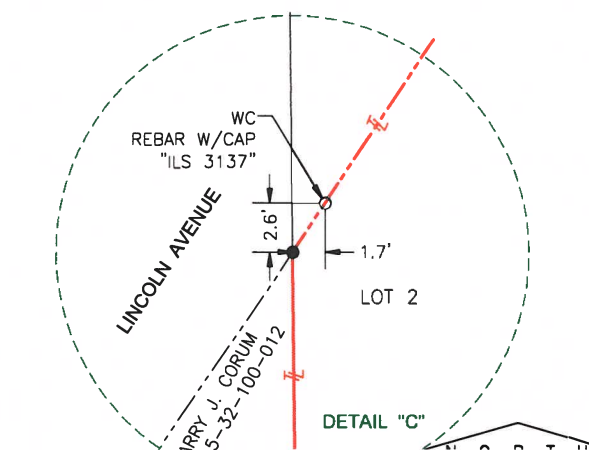
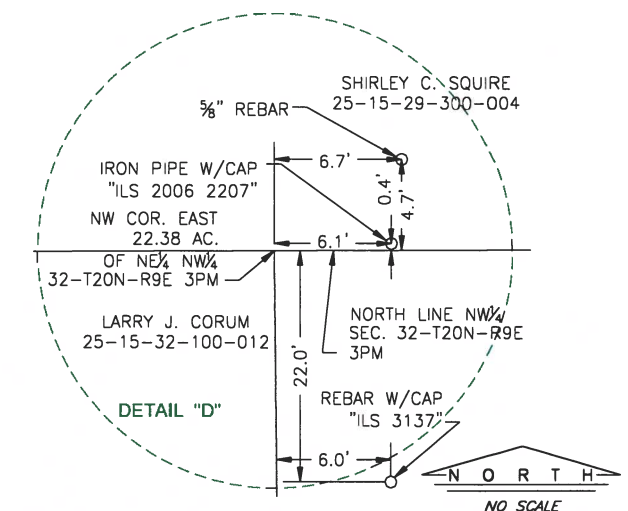
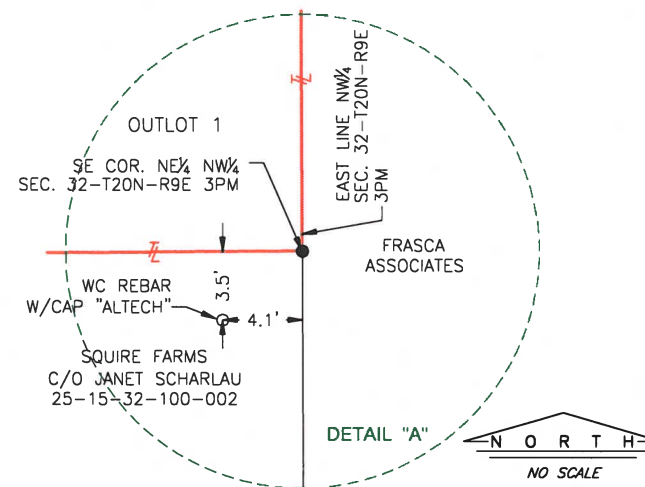
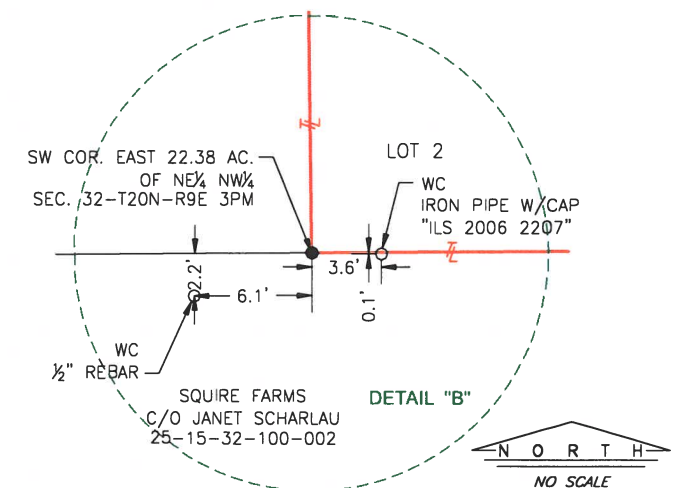

**KALANTZIS/COPE FIRST SUBDIVISION  
PART OF THE NORTHEAST QUARTER  
OF THE NORTHWEST QUARTER  
OF SECTION 32, TOWNSHIP 20 NORTH,  
RANGE 9 EAST OF THE THIRD PRINCIPAL  
MERIDIAN. SOMER TOWNSHIP  
CHAMPAIGN COUNTY, ILLINOIS**



**BERNS, CLANCY AND ASSOCIATES**  
ENGINEERS • SURVEYORS • PLANNERS  
405 EAST MAIN STREET - POST OFFICE BOX 755  
URBANA, ILLINOIS 61803-0755  
PHONE: (217) 384-1144 - FAX: (217) 384-3355

**Site Images for Case 056-S-22**  
(Images taken for Case 935-S-19 on April 9, 2019)



**Approximate pavilion location at forefront, lake and main house in distance**



**Path between residence and parking area used for events, facing northwest**

**Site Images for Case 056-S-22**  
(Images taken for Case 935-S-19 on April 9, 2019)



**Parking area used for events, facing east from main driveway**



**Main driveway, facing north**

**PRELIMINARY DRAFT**

**056-S-22**

**SUMMARY OF EVIDENCE, FINDING OF FACT  
AND FINAL DETERMINATION**

**of**

**Champaign County Zoning Board of Appeals**

Final Determination: *{GRANTED/ GRANTED WITH SPECIAL CONDITIONS/ DENIED}*

Date: *{July 14, 2022}*

Petitioners: **Bill Cope and Mary Kalantzis, d.b.a. Prairie Glass House, LLC**

Request: **Authorize the expansion of the Special Use Permit approved in Case 935-S-19 for a combination “Private Indoor Recreational Development” and “Outdoor Commercial Recreational Enterprise” to include a proposed detached accessory pavilion on land in the AG-2 Agriculture Zoning District.**

**Table of Contents**

**General Application Information.....2 - 4**

**Specific Ordinance Requirements.....4 - 8**

**Special Use Evidence .....8 - 20**

**Documents of Record..... 21**

**Case 056-S-22 Finding of Fact ..... 22 – 25**

**Case 056-S-22 Final Determination.....26 - 27**

***PRELIMINARY DRAFT***

**SUMMARY OF EVIDENCE**

From the documents of record and the testimony and exhibits received at the public hearing conducted on **July 14, 2022**, the Zoning Board of Appeals of Champaign County finds that:

1. Petitioners Bill Cope and Mary Kalantzis own the subject property. They are the sole shareholders and officers of Prairie Glass House, LLC.
2. The subject property is a 17.2 acre tract that is approximately in the East Half of the Northeast Quarter of the Northwest Quarter of Section 32, Township 20 North, Range 9 East of the Third Principal Meridian in Somer Township, and commonly known as the residence at 4018 North Lincoln Avenue, Champaign.
3. Regarding municipal extraterritorial jurisdiction and township planning jurisdiction:
  - A. The subject property is within the one and one-half mile extraterritorial jurisdiction of the City of Urbana, a municipality with zoning. Zoned municipalities do not have protest rights in Special Use Permit cases, but notice of the public hearing was sent to the City.
  - B. The subject property is located within Somer Township, which does not have a Planning Commission.

***GENERALLY REGARDING LAND USE AND ZONING IN THE IMMEDIATE VICINITY***

4. Land use and zoning on the subject property and in the vicinity are as follows:
  - A. The 17.2 acre subject property is currently split-zoned AG-2 Agriculture and CR Conservation Recreation and has both residential and event center uses. The event center is only allowed in the AG-2 portion of the subject property.
  - B. Land to the north is zoned CR Conservation Recreation to the east of Lincoln Avenue and AG-2 Agriculture to the west of Lincoln Avenue, and has a mix of agricultural and residential uses.
  - C. Land to the east is zoned CR Conservation Recreation and has a mix of agricultural and residential uses.
  - D. Land to the south is zoned CR Conservation Recreation and is in agricultural production.
  - E. Land to the west is zoned CR Conservation Recreation and AG-2 Agriculture, and is in agricultural production.

***GENERALLY REGARDING THE PROPOSED SPECIAL USE***

5. Regarding the site plan and operations of the proposed Special Use:
  - A. The Site Plan received May 18, 2022, indicates the following existing and proposed features:
    - (1) Existing features include:
      - a. A 7,638 square feet primary residence, located east of the circle drive;

**PRELIMINARY DRAFT****Case 056-S-22****Page 3 of 27**

- b. A two-story detached garage, which includes a second, illegal residence on the upper floor;
  - c. A gravel access drive extending from North Lincoln Avenue;
  - d. No septic system location information was provided.
  - e. No well location information was provided.
- (2) Proposed features include:
- a. One 60 feet by 90 feet (5,400 square feet) enclosed pavilion for event center use.
  - b. The petitioner plans to install a new septic system east of the detached garage to serve the dwelling, and also plans to install a second septic system for the pavilion, making sure to place it outside the floodplain.
- B. The petitioners are finalizing required subdivision plans with the City of Urbana, which include the following details:
- (1) Proposed Lot 1 would be in the existing AG-2 Agriculture Zoning District and would include the main house and event center features, including the proposed pavilion.
  - (2) Proposed Lot 2 would be in the existing AG-2 Agriculture Zoning District and would include the accessory garage with the upstairs dwelling unit. The approval of the proposed subdivision would make the currently illegal dwelling unit legal.
  - (3) Outlot 1 would be in the existing CR Conservation Recreation District and no construction could occur in that area.
  - (4) The proposed new driveway with a new access onto Lincoln Avenue will also need to be approved.
- C. Previous zoning permits for the subject property include:
- (1) ZUPA # 150-07-03 was approved on June 19, 2007, to construct a single-family residence with a detached garage.
  - (2) ZUPA #226-20-01 was approved on September 16, 2020, to authorize a Change of Use Permit for the event center.
- D. Previous zoning cases for the subject property include:
- (1) Case 573-AM-06 was also approved on March 29, 2007 to authorize an RRO with three single-family residential lots in the CR Conservation Recreation district, in addition to the three lots that could be built by right on this property, for a total of six buildable lots. The RRO was never developed and expired.

**PRELIMINARY DRAFT**

- (2) Case 579-AM-07 was approved on March 29, 2007 to authorize rezoning the AG-2 Agriculture part to CR Conservation Recreation, placing the entire subject property in the CR district.
- (3) Cases 931-AM-19 and 932-S-19 were approved on August 15, 2019, to authorize an RRO with a total of five residential lots for the subject property. The RRO was never developed and expired.
- (4) Case 934-AM-19 was approved on September 19, 2019 to rezone the event center portion of the subject property from CR Conservation Recreation to AG-2 Agriculture.
- (5) Case 935-S-19 was approved on October 24, 2019 to authorize an event center as a Special Use Permit in the AG-2 Agriculture part of the subject property.

**GENERALLY REGARDING SPECIFIC ORDINANCE REQUIREMENTS**

6. Regarding authorization for a combined “Private Indoor Recreational Development” and “Outdoor Commercial Recreational Enterprise” in the AG-2 Agriculture Zoning DISTRICT in the *Zoning Ordinance*:
  - A. The following definitions from the *Zoning Ordinance* are especially relevant to the requested Special Use Permit (capitalized words are defined in the Ordinance):
    - (1) “ACCESSORY BUILDING” is a BUILDING on the same LOT with the MAIN or PRINCIPAL STRUCTURE, or the main or principal USE, either detached from or attached to the MAIN or PRINCIPAL STRUCTURE, and subordinate to and used for purposes customarily incidental to the MAIN or PRINCIPAL STRUCTURE, or the main or principal USE.
    - (2) “ACCESSORY USE” is a USE on the same LOT customarily incidental and subordinate to the main or principal USE or MAIN or PRINCIPAL STRUCTURE.
    - (3) “AGRICULTURE” is the growing, harvesting and storing of crops including legumes, hay, grain, fruit and truck or vegetable crops, floriculture, horticulture, mushroom growing, orchards, forestry, and the keeping, raising, and feeding of livestock or poultry, including dairying, poultry, swine, sheep, beef cattle, pony and horse production, fur farms, and fish and wildlife farms; farm BUILDINGS used for growing, harvesting, and preparing crop products for market, or for use on the farm; roadside stands, farm BUILDINGS for storing and protecting farm machinery and equipment from the elements, for housing livestock or poultry and for preparing livestock or poultry products for market; farm DWELLINGS occupied by farm OWNERS, operators, tenants or seasonal or year-round hired farm workers. It is intended by this definition to include within the definition of AGRICULTURE all types of agricultural operations, but to exclude therefrom industrial operations such as a grain elevator, canning, or slaughterhouse, wherein agricultural products produced primarily by others are stored or processed. Agricultural purposes include, without limitation, the growing, developing, processing, conditioning, or selling of hybrid seed corn, seed beans, seed oats, or other farm seeds.



**PRELIMINARY DRAFT****Case 056-S-22****Page 5 of 27**

- (4) “AREA, LOT” is the total area within the LOT LINES.
- (5) “BUILDING” is an enclosed STRUCTURE having a roof supported by columns, walls, arches, or other devices and used for the housing, shelter, or enclosure of persons, animal, and chattels.
- (6) “BUILDING, DETACHED” is a BUILDING having no walls in common with other BUILDINGS.
- (7) “BUILDING, MAIN or PRINCIPAL” is the BUILDING in which is conducted the main or principal USE of the LOT on which it is located.
- (8) “LOT” is a designated parcel, tract or area of land established by PLAT, SUBDIVISION or as otherwise permitted by law, to be used, developed or built upon as a unit.
- (9) “PARKING SPACE” is a space ACCESSORY to a USE or STRUCTURE for the parking of one vehicle.
- (10) “PUBLIC ASSEMBLY USE” is a USE where more than fifty persons congregate or assemble for any purpose, including a cabaret, banquet hall, church, concert hall, dance hall, exhibition hall, lecture room, music hall, THEATER, grandstand, tents and similar outdoor and indoor USES.
- (11) “SPECIAL CONDITION” is a condition for the establishment of a SPECIAL USE.
- (12) “SPECIAL USE” is a USE which may be permitted in a DISTRICT pursuant to, and in compliance with, procedures specified herein.
- (13) “STREET” is a thoroughfare dedicated to the public within a RIGHT-OF-WAY which affords the principal means of ACCESS to abutting PROPERTY. A STREET may be designated as an avenue, a boulevard, a drive, a highway, a lane, a parkway, a place, a road, a thoroughfare, or by other appropriate names. STREETS are identified on the Official Zoning Map according to type of USE, and generally as follows:
  - (a) MAJOR STREET: Federal or State highways.
  - (b) COLLECTOR STREET: COUNTY highways and urban arterial STREETS.
  - (c) MINOR STREET: Township roads and other local roads.
- (14) “SUITED OVERALL” is a discretionary review performance standard to describe the site on which a development is proposed. A site may be found to be SUITED OVERALL if the site meets these criteria:
  - a. The site features or site location will not detract from the proposed use;
  - b. The site will not create a risk to health, safety or property of the occupants, the neighbors or the general public;
  - c. The site is not clearly inadequate in one respect even if it is acceptable in other respects;

**PRELIMINARY DRAFT**

- d. Necessary infrastructure is in place or provided by the proposed development; and
  - e. Available public services are adequate to support the proposed development effectively and safely.
- (15) “USE” is the specific purpose for which land, a STRUCTURE or PREMISES, is designed, arranged, intended, or for which it is or may be occupied or maintained. The term “permitted USE” or its equivalent shall not be deemed to include any NONCONFORMING USE.
- B. Subsection 6.1 contains standard conditions that apply to all SPECIAL USES, standard conditions that may apply to all SPECIAL USES, and standard conditions for specific types of SPECIAL USES. Relevant requirements from Subsection 6.1 are as follows:
- (1) Paragraph 6.1.2 A. indicates that all Special Use Permits with exterior lighting shall be required to minimize glare on adjacent properties and roadways by the following means:
    - a. All exterior light fixtures shall be full-cutoff type lighting fixtures and shall be located and installed so as to minimize glare and light trespass. Full cutoff means that the lighting fixture emits no light above the horizontal plane.
    - b. No lamp shall be greater than 250 watts and the Board may require smaller lamps when necessary.
    - c. Locations and numbers of fixtures shall be indicated on the site plan (including floor plans and building elevations) approved by the Board.
    - d. The Board may also require conditions regarding the hours of operation and other conditions for outdoor recreational uses and other large outdoor lighting installations.
    - e. The Zoning Administrator shall not approve a Zoning Use Permit without the manufacturer’s documentation of the full-cutoff feature for all exterior light fixtures.
  - (2) Subsection 6.1.3 establishes the following standard condition for an Outdoor Commercial Recreational Enterprise:
    - a. A separation distance of 200 feet between any R DISTRICT or residential or INSTITUTIONAL USE.
- C. Section 7.4.1 refers to parking requirements for a facility such as the proposed Special Use:
- (1) For BUILDINGS and other enclosed STRUCTURES, one PARKING SPACE for each five seats provided for patrons use, or at least one PARKING SPACE for each 200 square feet of floor area, whichever requires the greater number of PARKING SPACES.
  - (2) For outdoor areas, including non-permanent STRUCTURES, used for exhibit, educational, entertainment, recreational, or other purpose involving assemblage of patrons, one PARKING SPACE per three patrons based on the estimated number of patrons during peak attendance on a given day during said USE is in operation.
  - (3) When a USE involves a combination of enclosed BUILDINGS or STRUCTURES and an outdoor area, the required PARKING SPACES shall be calculated

**PRELIMINARY DRAFT****Case 056-S-22****Page 7 of 27**

separately per the above standards and then totaled to obtain the required PARKING SPACES for said USE.

- (4) Section 7.4.1 C.4. states that required parking screens for commercial establishments shall be provided as follows:
- a. Parking areas for more than four vehicles of no more than 8,000 pounds gross vehicle weight each, excluding any vehicles used for hauling solid waste except those used for hauling construction debris and other inert materials, located within any YARD abutting any residential DISTRICT or visible from and located within 100 feet from the BUILDING RESTRICTION LINE of a lot containing a DWELLING conforming as to USE shall be screened with a Type A SCREEN except that a TYPE B SCREEN may be erected along the rear LOT LINE of the business PROPERTY.
  - b. Parking areas for any number of vehicles exceeding 8,000 pounds in gross vehicle weight each or any number of vehicles used for hauling solid waste except those used for hauling construction debris and other inert materials located within any YARD abutting any residential DISTRICT or visible from and located within 100 feet from the BUILDING RESTRICTION LINE of a lot containing a DWELLING conforming as to USE shall be screened with a Type D SCREEN.
- D. Section 9.1.11 requires that a Special Use Permit shall not be granted by the Zoning Board of Appeals unless the public hearing record and written application demonstrate the following:
- (1) That the Special Use is necessary for the public convenience at that location.
  - (2) That the Special Use is so designed, located, and proposed as to be operated so that it will not be injurious to the DISTRICT in which it shall be located or otherwise detrimental to the public welfare except that in the CR, AG-1, and AG-2 DISTRICTS the following additional criteria shall apply:
    - a. The property is either BEST PRIME FARMLAND and the property with proposed improvements in WELL SUITED OVERALL or the property is not BEST PRIME FARMLAND and the property with proposed improvements is SUITED OVERALL.
    - b. The existing public services are available to support the proposed SPECIAL USE effectively and safely without undue public expense.
    - c. The existing public infrastructure together with proposed improvements is adequate to support the proposed development effectively and safely without undue public expense.
  - (3) That the Special Use conforms to the applicable regulations and standards of and preserves the essential character of the DISTRICT in which it shall be located, except where such regulations and standards are modified by Section 6.
  - (4) That the Special Use is in harmony with the general purpose and intent of this ordinance.

**PRELIMINARY DRAFT**

- (5) That in the case of an existing NONCONFORMING USE, it will make such USE more compatible with its surroundings.
- E. Paragraph 9.1.11.D.2. states that in granting any SPECIAL USE permit, the BOARD may prescribe SPECIAL CONDITIONS as to appropriate conditions and safeguards in conformity with the Ordinance. Violation of such SPECIAL CONDITIONS when made a party of the terms under which the SPECIAL USE permit is granted, shall be deemed a violation of this Ordinance and punishable under this Ordinance.

**GENERALLY REGARDING WHETHER THE SPECIAL USE IS NECESSARY FOR THE PUBLIC CONVENIENCE AT THIS LOCATION**

7. Generally regarding the *Zoning Ordinance* requirement that the proposed Special Use is necessary for the public convenience at this location:
- A. The Petitioner has testified on the application, **“There is demand for weddings in natural settings. Site is part of Big Grove forest.”**
- B. The subject property has a manmade pond, natural wooded areas and a former tree farm. The petitioner continues to maintain this rural, wooded environment and clients seek this same environment for their special events.
- C. The subject property has been in use as an event center for several years.

**GENERALLY REGARDING WHETHER THE SPECIAL USE WILL BE INJURIOUS TO THE DISTRICT OR OTHERWISE INJURIOUS TO THE PUBLIC WELFARE**

8. Generally regarding the *Zoning Ordinance* requirement that the proposed Special Use be designed, located, and operated so that it will not be injurious to the District in which it shall be located, or otherwise detrimental to the public welfare:
- A. The Petitioner has testified on the application, **“We plan to preserve trees and blend with natural setting. No land will be taken out of production.”**
- B. Regarding surface drainage:
- (1) Parts of the subject property are located in the Special Flood Hazard Area, per FEMA FIRM panel 17019C0314D (effective October 2, 2013).
  - (2) No existing structures are in the Special Flood Hazard Area and the proposed pavilion would require a Floodplain Development Permit.
  - (3) The existing event center and proposed expansion do not trigger the requirement for a Storm Water Drainage Plan.
  - (4) The subject property drains directly to the Saline Branch Drainage Ditch.
  - (5) The Saline Branch Drainage Ditch runs through the southeast corner of the subject property. The Beaver Lake Drainage District was notified of this case, and no comments have been received.

**PRELIMINARY DRAFT****Case 056-S-22****Page 9 of 27**

- C. Regarding the effects on traffic:
- (1) The subject property fronts North Lincoln Avenue along its new alignment. Regarding the general traffic conditions at this location, the level of existing traffic, and potential change due to the proposed Special Use:
    - a. The Illinois Department of Transportation measures traffic on various roads throughout the County. IDOT determines the annual average 24-hour traffic volume for those roads and reports it as Annual Average Daily Traffic (AADT). The most recent AADT data near the subject property is from 2021. North Lincoln Avenue near the subject property had an AADT of 2,300.
    - b. The event center has been in operation for several years, so any increase in traffic should not be significant in terms of safety. No formal Traffic Impact Analysis has been done, however.
    - c. The Somer Township Highway Commissioner has been notified of this case, and no comments have been received.
- D. Regarding fire protection, the subject property is located approximately 3.4 road miles from the Eastern Prairie Fire Protection District station; the approximate travel time is 7 minutes. Notification of this case was sent to the FPD Chief, and no comments have been received.
- E. Regarding soils on the subject property:
- (1) The subject property is NOT considered BEST PRIME FARMLAND. The soil on the subject property consists of 3107A Sawmill silty clay loam, 236A Sabina silt loam, and 233B Birkbeck silt loam, and has an average LE of 86.
  - (2) The event center is located on already disturbed land that has not been in agricultural production for many years.
- F. Regarding outdoor lighting on the subject property:
- (1) Most existing outdoor lighting is comprised of string lights connecting between stakes, structures, and trees. Existing lighting does not have to be full cutoff in design, but any future outdoor lighting installed for the event center must be full cutoff. A special condition has been added to ensure compliance with Section 6.1.2 of the Zoning Ordinance.
- G. Regarding wastewater treatment and disposal on the subject property:
- (1) The subject property residences have a septic system.
  - (2) The petitioners plan to install a new septic system for the property that would be east of the garage on Lot 2.
  - (3) A special condition has been added to ensure that a septic system of sufficient size is approved by the Champaign County Health Department.

***PRELIMINARY DRAFT***

- H. Regarding life safety considerations related to the proposed Special Use:
- (1) Champaign County has not adopted a building code. Life safety considerations are considered to a limited extent in Champaign County land use regulation as follows:
    - a. The Office of the State Fire Marshal has adopted the Code for Safety to Life from Fire in Buildings and Structures as published by the National Fire Protection Association (NFPA 101) 2000 edition, Life Safety Code, as the code for Fire Prevention and Safety as modified by the Fire Prevention and Safety Rules, 41 Ill. Adm Code 100, that applies to all localities in the State of Illinois.
    - b. The Office of the State Fire Marshal is authorized to enforce the Fire Prevention and Safety Rules and the code for Fire Prevention and Safety and will inspect buildings based upon requests of state and local government, complaints from the public, or other reasons stated in the Fire Prevention and Safety Rules, subject to available resources.
    - c. The Office of the State Fire Marshal currently provides a free building plan review process subject to available resources and subject to submission of plans prepared by a licensed architect, professional engineer, or professional designer that are accompanied by the proper Office of State Fire Marshal Plan Submittal Form.
    - d. Compliance with the code for Fire Prevention and Safety is mandatory for all relevant structures anywhere in the State of Illinois whether or not the Office of the State Fire Marshal reviews the specific building plans.
    - e. Compliance with the Office of the State Fire Marshal's code for Fire Prevention and Safety is not required as part of the review and approval of Zoning Use Permit Applications.
    - f. The Illinois Environmental Barriers Act (IEBA) requires the submittal of a set of building plans and certification by a licensed architect that the specific construction complies with the Illinois Accessibility Code for all construction projects worth \$50,000 or more and requires that compliance with the Illinois Accessibility Code be verified for all Zoning Use Permit Applications for those aspects of the construction for which the Zoning Use Permit is required.
    - g. The Illinois Accessibility Code incorporates building safety provisions very similar to those of the code for Fire Prevention and Safety.
    - h. The certification by an Illinois licensed architect that is required for all construction projects worth \$50,000 or more should include all aspects of compliance with the Illinois Accessibility Code including building safety provisions very similar to those of the code for Fire Prevention and Safety.
    - i. When there is no certification required by an Illinois licensed architect, the only aspects of construction that are reviewed for Zoning Use Permits and

**PRELIMINARY DRAFT****Case 056-S-22****Page 11 of 27**

which relate to aspects of the Illinois Accessibility Code are the number and general location of required building exits.

- j. Verification of compliance with the Illinois Accessibility Code applies only to exterior areas. With respect to interiors, it means simply checking that the required number of building exits is provided and that they have the required exterior configuration. This means that other aspects of building design and construction necessary to provide a safe means of egress from all parts of the building are not checked.
- I. Other than as reviewed elsewhere in this Summary of Evidence, there is no evidence to suggest that the proposed Special Use will generate either nuisance conditions such as odor, noise, vibration, glare, heat, dust, electromagnetic fields or public safety hazards such as fire, explosion, or toxic materials release, that are in excess of those lawfully permitted and customarily associated with other uses permitted in the zoning district.

***GENERALLY REGARDING WHETHER THE SPECIAL USE CONFORMS TO APPLICABLE REGULATIONS AND STANDARDS AND PRESERVES THE ESSENTIAL CHARACTER OF THE DISTRICT***

9. Generally regarding the *Zoning Ordinance* requirement that the proposed Special Use conform to all applicable regulations and standards and preserve the essential character of the District in which it shall be located, except where such regulations and standards are modified by Section 6 of the Ordinance:
- A. The Petitioner has testified on the application: “Yes.”
  - B. Regarding compliance with the *Zoning Ordinance*:
    - (1) A Private Indoor Recreational Development is authorized by Special Use Permit in the AG-2 Agriculture, R-3 Residential, and R-4 Residential Zoning Districts and by right in the B-2, B-3, and B-4 Zoning Districts.
    - (2) An Outdoor Commercial Recreational Enterprise is authorized by Special Use Permit in the CR Conservation-Recreation and AG-2 Agriculture Zoning Districts and by right in the B-3, B-4, B-5, I-1 and I-2 Zoning Districts.
    - (3) Regarding the requirement for a separation distance of 200 feet between the Special Use and any R DISTRICT or residential or INSTITUTIONAL USE for the Outdoor Commercial Recreational Enterprise part of the event center:
      - a. The nearest residential lot is located northeast of the main residence.
      - b. The shared lot line is roughly 30 feet from the existing grass parking area used for events.
      - c. The neighbor’s detached garage partially obstructs the view of the parking area from the neighbor’s residence.
      - d. As part of case 935-S-19, a waiver was approved for allowing less than 200 feet separation between an event center and a residential lot.

**PRELIMINARY DRAFT**

- (4) Regarding parking on the subject property for the proposed Special Use:
- a. The petitioners only plan to hold events in the pavilion, and anticipate a maximum capacity of 150 guests.
    - (a) Per the Zoning Ordinance, one parking space is required for every five guests for indoor facilities, so 30 parking spaces would be required on the subject property.
  - b. There is grass parking for the event center on the property; the petitioner stated during case 935-S-19 that approximately 100 to 125 cars can fit in the space. This parking area connects to the main residence/event center via either the gravel driveway or a dirt track road to the back yard/outdoor events area.
    - (a) As part of case 935-S-19, Jason Brown, Chief of the Eastern Prairie Fire Protection District, toured the event center on April 15, 2019, and provided the following comments in an email sent to William Cope and Susan Burgstrom:
      - i. “We don’t have any concerns with the property or building for the event usage. The lane/ Drive is wide enough as long as all parking stays in the provided lot. Only recommendation we made was they have some fire extinguisher on hand.”
      - ii. When asked by Susan Burgstrom about guest parking along the driveway and available width for emergency vehicles, Chief Brown recommended that no parking be allowed on the driveway.
      - iii. A special condition has been added to the Special Use Permit regarding parking on the driveway.
  - c. The Site Plan received May 18, 2022 indicates diagonal parking along a new driveway that parallels the driveway to the house and garage. The diagonal parking could accommodate approximately 96 vehicles.
  - d. There is a concrete parking area used for accessible parking spaces in front of the detached garage; there is room for four accessible parking spaces in this area. This parking area connects to the main residence’s semicircle drive via a 36-inch wide sidewalk.
  - e. Per Section 7.4.1 C.4., a TYPE A SCREEN is required for commercial establishments that are visible from and located within 100 feet from the BUILDING RESTRICTION LINE of a lot containing a DWELLING conforming as to USE.
    - (a) A TYPE A SCREEN is a decorative opaque fence, shrubs or other vegetative material or a landscaped berm planted and maintained with a minimum HEIGHT of four feet as measured from the highest adjacent grade.



**PRELIMINARY DRAFT****Case 056-S-22**  
**Page 13 of 27**

- (b) A special condition of case 935-S-19 was that screening needed to be added so the event center parking would not be visible from the residential lot. Due to COVID-19, no events were held for a period of time and no screening was established.
  - (c) A special condition has been added to this case to ensure that requirement will be met.
- C. Regarding compliance with the *Storm Water Management and Erosion Control Ordinance*:
  - (1) The proposed Special Use expansion does not trigger the requirement for a Storm Water Drainage Plan.
- D. Regarding the Special Flood Hazard Areas Ordinance:
  - (1) Parts of the subject property are located in the Special Flood Hazard Area, per FEMA FIRM panel 17019C0314D (effective October 2, 2013).
  - (2) No existing structures are in the Special Flood Hazard Area and the proposed pavilion would require a Floodplain Development Permit.
- E. Regarding the Subdivision Regulations, the subject property is located in the City of Urbana subdivision jurisdiction and the petitioners are applying for a two lot plus one outlot subdivision with the City.
  - (1) The authorization for the event center expansion is not contingent on subdividing the property.
- F. Regarding the requirement that the Special Use preserve the essential character of the AG-2 Agriculture Zoning District:
  - (1) A Private Indoor Recreational Development may be authorized by Special Use Permit in the AG-2 Agriculture Zoning District.
  - (2) An Outdoor Commercial Recreational Enterprise may be authorized by Special Use Permit in the AG-2 Agriculture Zoning District.
  - (3) The proposed use will not hinder agricultural production.
- G. Regarding whether or not the proposed Special Use will preserve the essential character of the surrounding CR District:
  - (1) Five of the six types of uses authorized by right in the CR DISTRICT are the same as by-right uses in the AG-2 DISTRICT. However, a Private Indoor Recreational Development (the indoor part of the event center) is only authorized as a Special Use in the AG-2 District and not the CR District.
  - (2) Split-zoning the subject property better preserves the essential character of the surrounding CR District because it will better protect the Saline Branch Drainage Ditch.
- H. The proposed Special Use must comply with the Illinois Accessibility Code, which is not a County ordinance or policy and the County cannot provide any flexibility regarding that

**PRELIMINARY DRAFT**

Code. A Zoning Use Permit cannot be issued for any part of the proposed Special Use until full compliance with the Illinois Accessibility Code has been indicated in drawings.

**GENERALLY REGARDING WHETHER THE SPECIAL USE IS IN HARMONY WITH THE GENERAL PURPOSE AND INTENT OF THE ORDINANCE**

10. Regarding the *Zoning Ordinance* requirement that the proposed Special Use be in harmony with the general intent and purpose of the Ordinance:
  - A. A Private Indoor Recreational Development is authorized by Special Use Permit in the AG-2 Agriculture, R-3 Residential, and R-4 Residential Zoning District and by right in the B-2, B-3, and B-4 Zoning Districts.
  - B. An Outdoor Commercial Recreational Enterprise is authorized by Special Use Permit in the CR Conservation-Recreation and AG-2 Agriculture Zoning Districts and by right in the B-3, B-4, B-5, I-1 and I-2 Zoning Districts. Note that the Outdoor Commercial Recreational Enterprise and the Private Indoor Recreational Development are actually the same proposed use and not separate uses, which would not be permissible on a lot in the CR District.
  - C. Regarding whether the proposed Special Use Permit is in harmony with the general intent of the Zoning Ordinance:
    - (1) Subsection 5.1.2 of the Ordinance states the general intent of the AG-2 District and states as follows (capitalized words are defined in the Ordinance):
 

The AG-2, Agriculture DISTRICT is intended to prevent scattered indiscriminate urban development and to preserve the AGRICULTURAL nature within areas which are predominately vacant and which presently do not demonstrate any significant potential for development. This DISTRICT is intended generally for application to areas within one and one-half miles of existing communities in the COUNTY.
    - (2) Subsection 5.1.3 of the Ordinance states the general intent of the CR District and states as follows (capitalized words are defined in the Ordinance):
 

The CR, Conservation-Recreation DISTRICT is intended to protect the public health by restricting development in areas subject to frequent or periodic floods and to conserve the natural and scenic areas generally along the major stream networks of the COUNTY.
    - (3) The types of uses authorized in the AG-2 and CR Districts are in fact the types of uses that have been determined to be acceptable in each District. Uses authorized by Special Use Permit are acceptable uses in each district provided that they are determined by the ZBA to meet the criteria for Special Use Permits established in paragraph 9.1.11 B. of the Ordinance.
  - D. Regarding the purpose of the Zoning Ordinance as established in Section 2 of the Ordinance:
    - (1) Paragraph 2.0 (a) of the Ordinance states that one purpose of the zoning regulations and standards that have been adopted and established is to secure adequate light, pure air, and safety from fire and other dangers.

**PRELIMINARY DRAFT****Case 056-S-22**  
**Page 15 of 27**

This purpose is directly related to the limits on building coverage and the minimum yard requirements in the Ordinance and the proposed site plan appears to be in compliance with those requirements.

- (2) Paragraph 2.0 (b) of the Ordinance states that one purpose of the zoning regulations and standards that have been adopted and established is to conserve the value of land, BUILDINGS, and STRUCTURES throughout the COUNTY.
- a. It is not clear if the proposed Special Use Permit expansion would have any impact on the value of nearby properties without a formal real estate appraisal, which has not been requested nor provided, and so any discussion of values is necessarily general.
  - b. The proposed Special Use Permit expansion could only have an effect on the value of real estate in the immediate vicinity. Regarding the effect on the value of real estate in the immediate vicinity other than the subject property:
    - (a) Both a “Private Indoor Recreational Development” and an “Outdoor Commercial Recreational Enterprise” that together comprise the event center use are authorized by Special Use Permit in the AG-2 Zoning District, and therefore the Zoning Ordinance apparently has a presumption of no inherent incompatibilities between agricultural and residential uses and an event center.
    - (b) An “Outdoor Commercial Recreational Enterprise” is authorized by Special Use Permit in the CR Zoning District, and therefore the Zoning Ordinance apparently has a presumption of no inherent incompatibilities between natural areas along stream corridors and outdoor events.
    - (c) Provided that the special conditions of approval sufficiently mitigate or minimize any incompatibilities between the proposed Special Use Permit expansion and adjacent properties, there should be no significant effect on the value of nearby properties.
  - c. In regards to the value of the subject property, it is not clear if the requested rezoning and Special Use Permit would have any effect.
- (3) Paragraph 2.0 (c) of the Ordinance states that one purpose of the zoning regulations and standards that have been adopted and established is to lessen and avoid congestion in the public streets.
- a. Probable traffic impacts are reviewed under Item 8.C. of this Summary of Evidence.
    - (a) The traffic generated by the proposed use will primarily occur during evenings and weekends.
    - (b) The event center has been in operation for several years, so any increase in traffic should not be significant in terms of safety. No formal Traffic Impact Analysis has been done, however.

***PRELIMINARY DRAFT***

- (4) Paragraph 2.0 (d) of the Ordinance states that one purpose of the zoning regulations and standards that have been adopted and established is to lessen and avoid hazards to persons and damage to property resulting from the accumulation of runoff of storm or flood waters.
- a. Parts of the subject property are located in the Special Flood Hazard Area, per FEMA FIRM panel 17019C0314D (effective October 2, 2013).
  - b. No existing structures are in the Special Flood Hazard Area and the proposed pavilion would require a Floodplain Development Permit.
  - c. The existing event center does not trigger the requirement for a Storm Water Drainage Plan.
  - d. The proposed pavilion for the event center does not trigger the requirement for a Storm Water Drainage Plan.
  - e. The subject property drains directly to the Saline Branch Drainage Ditch.
  - f. The Saline Branch Drainage Ditch runs through the southeast corner of the subject property. The Beaver Lake Drainage District was notified of this case, and no comments have been received.
- (5) Paragraph 2.0 (e) of the Ordinance states that one purpose of the zoning regulations and standards that have been adopted and established is to promote the public health, safety, comfort, morals, and general welfare.
- a. In regards to public safety, this purpose is similar to the purpose established in paragraph 2.0 (a) and is in harmony to the same degree.
  - b. In regards to public comfort and general welfare, this purpose is similar to the purpose of conserving property values established in paragraph 2.0 (b) and is in harmony to the same degree.
  - c. Adjacent landowners have been notified of these zoning cases, and no comments have been received regarding the proposed expansion.
- (6) Paragraph 2.0 (f) states that one purpose of the Ordinance is regulating and limiting the height and bulk of BUILDINGS and STRUCTURES hereafter to be erected; and paragraph 2.0 (g) states that one purpose is establishing, regulating, and limiting the BUILDING or SETBACK lines on or along any STREET, trafficway, drive or parkway; and paragraph 2.0 (h) states that one purpose is regulating and limiting the intensity of the USE of LOT AREAS, and regulating and determining the area of OPEN SPACES within and surrounding BUILDINGS and STRUCTURES.

These three purposes are directly related to the limits on building height and building coverage and the minimum setback and yard requirements in the Ordinance and the proposed site plan appears to be in compliance with those limits.

**PRELIMINARY DRAFT****Case 056-S-22  
Page 17 of 27**

- (7) Paragraph 2.0 (i) of the Ordinance states that one purpose of the Ordinance is classifying, regulating, and restricting the location of trades and industries and the location of BUILDINGS, STRUCTURES, and land designed for specified industrial, residential, and other land USES; and paragraph 2.0 (j.) states that one purpose is dividing the entire COUNTY into DISTRICTS of such number, shape, area, and such different classes according to the USE of land, BUILDINGS, and STRUCTURES, intensity of the USE of LOT AREA, area of OPEN SPACES, and other classification as may be deemed best suited to carry out the purpose of the ordinance; and paragraph 2.0 (k) states that one purpose is fixing regulations and standards to which BUILDINGS, STRUCTURES, or USES therein shall conform; and paragraph 2.0 (l) states that one purpose is prohibiting USES, BUILDINGS, OR STRUCTURES incompatible with the character of such DISTRICT.

Harmony with these four purposes requires that the special conditions of approval sufficiently mitigate or minimize any incompatibilities between the proposed Special Use Permit and adjacent uses, and that the special conditions adequately mitigate any problematic conditions.

- (8) Paragraph 2.0 (m) of the Ordinance states that one purpose of the zoning regulations and standards that have been adopted and established is to prevent additions to and alteration or remodeling of existing buildings, structures, or uses in such a way as to avoid the restrictions and limitations lawfully imposed under this ordinance.

This purpose is directly related to maintaining compliance with the Zoning Ordinance requirements for the District and the specific types of uses and the proposed Special Use will have to be conducted in compliance with those requirements.

- (9) Paragraph 2.0 (n) of the Ordinance states that one purpose of the zoning regulations and standards that have been adopted and established is to protect the most productive agricultural lands from haphazard and unplanned intrusions of urban uses.

The proposed Special Use does not meet the definition of either “urban development” or “urban land use” as defined in the Appendix to Volume 2 of the Champaign County Land Resource Management Plan.

- (10) Paragraph 2.0 (o) of the Ordinance states that one purpose of the zoning regulations and standards that have been adopted and established is to protect natural features such as forested areas and watercourses.
- a. A Natural Resource Report was prepared by the Champaign County Soil and Water Conservation District and received on February 12, 2007 for the RRO approved in 2007, which discussed the types of soils and other site characteristics.
    - (a) Site-specific concerns stated in the report were the following:
      - i. The area that is to be developed has 2 soil types that have severe wetness restriction and one that has flooding

**PRELIMINARY DRAFT**

characteristics. This will be especially important for the septic systems that are planned.

- ii. The west portion of the tract has many trees that were planted as part of the Conservation Reserve Program. An effort to save or transplant the high quality trees should be made.
    - (i) The CRP contract ended on September 30, 2007.
  - b. There are no known wetlands, archaeological sites, or natural areas on the subject property according to State of Illinois inventories.
  - c. The subject property has a manmade pond, natural wooded areas and a former tree farm. The petitioner continues to maintain this rural, wooded environment and clients seek this same environment for their special events.
- (11) Paragraph 2.0 (p) of the Ordinance states that one purpose of the zoning regulations and standards that have been adopted and established is to encourage the compact development of urban areas to minimize the cost of development of public utilities and public transportation facilities.
- a. The proposed Special Use does not meet the definition of either “urban development” or “urban land use” as defined in the Appendix to Volume 2 of the Champaign County Land Resource Management Plan.
  - b. No public investment is required for utilities or transportation facilities related to the subject property.
- (12) Paragraph 2.0 (q) of the Ordinance states that one purpose of the zoning regulations and standards that have been adopted and established is to encourage the preservation of agricultural belts surrounding urban areas, to retain the agricultural nature of the County, and the individual character of existing communities.
- a. The subject property soils are not BEST PRIME FARMLAND.
  - b. There is no land in agricultural production on the subject property.
- (13) Paragraph 2.0 (r) of the Ordinance states that one purpose of the zoning regulations and standards that have been adopted and established is to provide for the safe and efficient development of renewable energy sources in those parts of the COUNTY that are most suited to their development.

The proposed Special Use will not hinder the development of renewable energy sources.

**GENERALLY REGARDING WHETHER THE SPECIAL USE IS AN EXISTING NONCONFORMING USE**

11. Regarding the *Zoning Ordinance* requirement that in the case of an existing NONCONFORMING USE the granting of the Special Use Permit will make the use more compatible with its surroundings:
- A. The Petitioner has testified on the application: **“Not applicable.”**

**PRELIMINARY DRAFT**

- B. The existing use on the property is not an existing nonconforming use.

**GENERALLY REGARDING PROPOSED SPECIAL CONDITIONS OF APPROVAL**

17. Regarding proposed special conditions of approval:

- A. **The Zoning Administrator shall not issue a Zoning Compliance Certificate for the proposed expansion to the Private Indoor Recreational Development/Outdoor Commercial Recreational Enterprise until the petitioner has demonstrated that the proposed Special Use complies with the Illinois Accessibility Code.**

The special condition stated above is required to ensure the following:

**That the proposed Special Use meets applicable State requirements for accessibility.**

- B. **The Zoning Administrator shall not authorize a Zoning Use Permit Application or issue a Zoning Compliance Certificate on the subject property until the lighting specifications in Paragraph 6.1.2.A. of the Zoning Ordinance have been met.**

The special condition stated above is required to ensure the following:

**That exterior lighting meets the requirements established for Special Uses in the Zoning Ordinance.**

- C. **All onsite Special Use activities shall be in compliance at all times with the Champaign County Health Ordinance, the Champaign County Liquor Ordinance, and the Champaign County Recreation and Entertainment Ordinance.**

The special condition stated above is required to ensure the following:

**That the proposed Special Use is in ongoing compliance with all applicable County requirements.**

- D. **The Petitioner shall ensure that the guests are made aware of the County Ordinance prohibiting nuisance noise past 10 pm and that the use of the facility requires compliance to avoid complaints from neighboring residences. Music and other nuisance noise shall not be audible at the property line past 10 pm.**

The special condition stated above is required to ensure the following:

**That events held on the subject property adequately consider neighbors.**

- E. **This special use permit does not authorize onsite food preparation or the construction of any food preparation area or kitchen.**

The special condition stated above is required to ensure the following:

**To protect public health.**

- F. **Within one year of approval of zoning case 056-S-22, the petitioners shall install a new septic system as approved by the Champaign County Health Department. If the septic system is not installed and approved by the Health Department within one year, the Special Use Permit shall be suspended until the septic system has been**

**PRELIMINARY DRAFT**

**installed and approved by the Health Department, and the following documentation shall be submitted to the Zoning Administrator:**

- (1) A true and correct copy of an approved COUNTY Health Department PERMIT for construction of the private sewage disposal system.**
- (2) A true and correct copy of the COUNTY Health Department Certificate of Approval for the private sewage disposal system shall be submitted to the Zoning Administrator prior to the use of any new septic system.**

The special condition stated above is required to ensure the following:

**Any new septic system is in compliance with the Champaign County Zoning Ordinance.**

- G. This Special Use Permit shall expire if no events are held during any consecutive 365-day period.**

The special condition stated above is required to ensure the following:

**To provide both a sense of continuity and a sense of closure to the neighbors.**

- H. Within six months of approval of Zoning Cases 056-S-22, the petitioner shall install a Type A screen along the petitioner's side of the shared property lines of the adjacent residence to the north with an address of 4102 N Lincoln Avenue, Champaign.**

The special condition stated above is required to ensure the following:

**That the event center parking area complies with Section 7.4.1.C.4. of the Zoning Ordinance.**

- I. No building construction is permitted in proposed Outlot 1.**

The special condition stated above is required to ensure the following:

**That no event center construction occurs in the CR Conservation Recreation Zoning District.**



***PRELIMINARY DRAFT***

**Case 056-S-22**  
**Page 21 of 27**

**DOCUMENTS OF RECORD**

1. Application for a Special Use Permit received June 1, 2022, with attachment:
  - A Proposed Site Plan received May 18, 2022
  - B Preliminary Plat by Berns, Clancy & Associates received May 18, 2022
  
2. Case 056-S-22 Preliminary Memorandum dated July 5, 2022, with attachments:
  - A Case Maps (Location, Land Use, Zoning)
  - B Proposed Site Plan received May 18, 2022
  - C Preliminary Plat by Berns, Clancy & Associates received May 18, 2022
  - D Site Visit Photos taken April 9, 2019 (from previous case 935-S-19)
  - E Draft Summary of Evidence, Finding of Fact and Final Determination for Case 056-S-22 dated July 14, 2022

**PRELIMINARY DRAFT****DRAFT SUMMARY FINDINGS OF FACT**

From the documents of record and the testimony and exhibits received at the public hearing for zoning case **056-S-22** held on **July 14, 2022**, the Zoning Board of Appeals of Champaign County finds that:

1. The requested Special Use Permit **{IS / IS NOT}** necessary for the public convenience at this location because:
  - a. *The subject property has a manmade pond, natural wooded areas and a former tree farm. The petitioner continues to maintain this rural, wooded environment and clients seek this same environment for their special events.*
  - b. *The subject property has been in use as an event center for several years.*
  
2. The requested Special Use Permit **{SUBJECT TO THE SPECIAL CONDITIONS IMPOSED HEREIN}** is so designed, located, and proposed to be operated so that it **{WILL / WILL NOT}** be injurious to the district in which it shall be located or otherwise detrimental to the public health, safety, and welfare because:
  - a. The street has **{ADEQUATE / INADEQUATE}** traffic capacity and the entrance location has **{ADEQUATE / INADEQUATE}** visibility.
  - b. Emergency services availability is **{ADEQUATE / INADEQUATE}** because\*:
    - a. *The subject property is located approximately 3.4 road miles from the Eastern Prairie Fire Protection District station; the approximate travel time is 7 minutes. Notification of these cases was sent to the FPD Chief, and no comments have been received.*
  - c. The Special Use **{WILL / WILL NOT}** be compatible with adjacent uses because\*:
    - a. *A special condition has been added to screen the adjacent residential lot to the north from the event center parking area.*
    - b. *No complaints have been received regarding the proposed expansion to the Special Use Permit.*
  - d. Surface and subsurface drainage will be **{ADEQUATE / INADEQUATE}** because\*:
    - a. *No existing structures are in the Special Flood Hazard Area and the proposed pavilion would require a Floodplain Development Permit.*
    - b. *The proposed pavilion does not trigger the need for a Storm Water Management Plan.*
  - e. Public safety will be **{ADEQUATE / INADEQUATE}** because\*:
    - a. *The petitioner checked with the Eastern Prairie Fire Protection District about the proposed development, and no comments have been received.*
  - f. The provisions for parking will be **{ADEQUATE / INADEQUATE}** because\*:
    - a. *The Site Plan received May 18, 2022 indicates approximately 96 parking spaces when only 30 are required for the proposed 150 maximum guests.*

(Note the Board may include other relevant considerations as necessary or desirable in each case.)

\*The Board may include additional justification if desired, but it is not required.

**PRELIMINARY DRAFT**

**Case 056-S-22**  
**Page 23 of 27**

- 3a. The requested Special Use Permit *{SUBJECT TO THE SPECIAL CONDITIONS IMPOSED HEREIN} {DOES / DOES NOT}* conform to the applicable regulations and standards of the DISTRICT in which it is located.
- 3b. The requested Special Use Permit *{SUBJECT TO THE SPECIAL CONDITIONS IMPOSED HEREIN} {DOES / DOES NOT}* preserve the essential character of the DISTRICT in which it is located because:
- The Special Use will be designed to *{CONFORM / NOT CONFORM}* to all relevant County ordinances and codes.
  - The Special Use *{WILL / WILL NOT}* be compatible with adjacent uses.
  - Public safety will be *{ADEQUATE / INADEQUATE}*.
4. The requested Special Use Permit *{SUBJECT TO THE SPECIAL CONDITIONS IMPOSED HEREIN} {IS / IS NOT}* in harmony with the general purpose and intent of the Ordinance because:
- The Special Use is authorized in the District.
  - The requested Special Use Permit *{IS / IS NOT}* necessary for the public convenience at this location.
  - The requested Special Use Permit *{SUBJECT TO THE SPECIAL CONDITIONS IMPOSED HEREIN}* is so designed, located, and proposed to be operated so that it *{WILL / WILL NOT}* be injurious to the district in which it shall be located or otherwise detrimental to the public health, safety, and welfare.
  - The requested Special Use Permit *{SUBJECT TO THE SPECIAL CONDITIONS IMPOSED HEREIN} {DOES / DOES NOT}* preserve the essential character of the DISTRICT in which it is located.
5. The requested Special Use *IS NOT* an existing nonconforming use.
6. ***THE SPECIAL CONDITIONS IMPOSED HEREIN ARE REQUIRED TO ENSURE COMPLIANCE WITH THE CRITERIA FOR SPECIAL USE PERMITS AND FOR THE PARTICULAR PURPOSES DESCRIBED BELOW:***

- A. **The Zoning Administrator shall not issue a Zoning Compliance Certificate for the proposed expansion to the Private Indoor Recreational Development/Outdoor Commercial Recreational Enterprise until the petitioner has demonstrated that the proposed Special Use complies with the Illinois Accessibility Code.**

The special condition stated above is required to ensure the following:

**That the proposed Special Use meets applicable State requirements for accessibility.**

- B. **The Zoning Administrator shall not authorize a Zoning Use Permit Application or issue a Zoning Compliance Certificate on the subject property until the lighting specifications in Paragraph 6.1.2.A. of the Zoning Ordinance have been met.**

The special condition stated above is required to ensure the following:

**That exterior lighting meets the requirements established for Special Uses in the Zoning Ordinance.**

**PRELIMINARY DRAFT**

- C. **All onsite Special Use activities shall be in compliance at all times with the Champaign County Health Ordinance, the Champaign County Liquor Ordinance, and the Champaign County Recreation and Entertainment Ordinance.**

The special condition stated above is required to ensure the following:

**That the proposed Special Use is in ongoing compliance with all applicable County requirements.**

- D. **The Petitioner shall ensure that the guests are made aware of the County Ordinance prohibiting nuisance noise past 10 pm and that the use of the facility requires compliance to avoid complaints from neighboring residences. Music and other nuisance noise shall not be audible at the property line past 10 pm.**

The special condition stated above is required to ensure the following:

**That events held on the subject property adequately consider neighbors.**

- E. **This special use permit does not authorize onsite food preparation or the construction of any food preparation area or kitchen.**

The special condition stated above is required to ensure the following:

**To protect public health.**

- F. **Within one year of approval of zoning case 056-S-22, the petitioners shall install a new septic system as approved by the Champaign County Health Department. If the septic system is not installed and approved by the Health Department within one year, the Special Use Permit shall be suspended until the septic system has been installed and approved by the Health Department, and the following documentation shall be submitted to the Zoning Administrator:**

(1) **A true and correct copy of an approved COUNTY Health Department PERMIT for construction of the private sewage disposal system.**

(2) **A true and correct copy of the COUNTY Health Department Certificate of Approval for the private sewage disposal system shall be submitted to the Zoning Administrator prior to the use of any new septic system.**

The special condition stated above is required to ensure the following:

**Any new septic system is in compliance with the Champaign County Zoning Ordinance.**

- G. **This Special Use Permit shall expire if no events are held during any consecutive 365-day period.**

The special condition stated above is required to ensure the following:

**To provide both a sense of continuity and a sense of closure to the neighbors.**

***PRELIMINARY DRAFT***

**Case 056-S-22  
Page 25 of 27**

- H. **Within six months of approval of Zoning Cases 056-S-22, the petitioner shall install a Type A screen along the petitioner's side of the shared property lines of the adjacent residence to the north with an address of 4102 N Lincoln Avenue, Champaign.**

The special condition stated above is required to ensure the following:

**That the event center parking area complies with Section 7.4.1.C.4. of the Zoning Ordinance.**

- I. **No building construction is permitted in proposed Outlot 1.**

The special condition stated above is required to ensure the following:

**That no event center construction occurs in the CR Conservation Recreation Zoning District.**

Case 056-S-22  
Page 26 of 27

**PRELIMINARY DRAFT**

**FINAL DETERMINATION**

The Champaign County Zoning Board of Appeals finds that, based upon the application, testimony, and other evidence received in this case, the requirements of Section 9.1.11B. for approval *{HAVE/ HAVE NOT}* been met, and pursuant to the authority granted by Section 9.1.6 B. of the Champaign County Zoning Ordinance, determines that:

The Special Use requested in Case **056-S-22** is hereby *{GRANTED/ GRANTED WITH SPECIAL CONDITIONS / DENIED}* to the applicants, **Bill Cope and Mary Kalantzis, d.b.a Prairie Glass House, LLC**, to authorize the following:

**Authorize the expansion of the Special Use Permit approved in Case 935-S-19 for a combination “Private Indoor Recreational Development” and “Outdoor Commercial Recreational Enterprise” to include a proposed detached accessory pavilion on land in the AG-2 Agriculture Zoning District.**

***{SUBJECT TO THE FOLLOWING SPECIAL CONDITIONS:}***

- A. **The Zoning Administrator shall not issue a Zoning Compliance Certificate for the proposed expansion to the Private Indoor Recreational Development/Outdoor Commercial Recreational Enterprise until the petitioner has demonstrated that the proposed Special Use complies with the Illinois Accessibility Code.**
- B. **The Zoning Administrator shall not authorize a Zoning Use Permit Application or issue a Zoning Compliance Certificate on the subject property until the lighting specifications in Paragraph 6.1.2.A. of the Zoning Ordinance have been met.**
- C. **All onsite Special Use activities shall be in compliance at all times with the Champaign County Health Ordinance, the Champaign County Liquor Ordinance, and the Champaign County Recreation and Entertainment Ordinance.**
- D. **The Petitioner shall ensure that the guests are made aware of the County Ordinance prohibiting nuisance noise past 10 pm and that the use of the facility requires compliance to avoid complaints from neighboring residences. Music and other nuisance noise shall not be audible at the property line past 10 pm.**
- E. **This special use permit does not authorize onsite food preparation or the construction of any food preparation area or kitchen.**
- F. **Within one year of approval of zoning case 056-S-22, the petitioners shall install a new septic system as approved by the Champaign County Health Department. If the septic system is not installed and approved by the Health Department within one year, the Special Use Permit shall be suspended until the septic system has been installed and approved by the Health Department, and the following documentation shall be submitted to the Zoning Administrator:**
  - (1) **A true and correct copy of an approved COUNTY Health Department PERMIT for construction of the private sewage disposal system.**

**PRELIMINARY DRAFT**

**Case 056-S-22  
Page 27 of 27**

- (2) A true and correct copy of the COUNTY Health Department Certificate of Approval for the private sewage disposal system shall be submitted to the Zoning Administrator prior to the use of any new septic system.**
  
- G. This Special Use Permit shall expire if no events are held during any consecutive 365-day period.**
  
- H. Within six months of approval of Zoning Cases 056-S-22, the petitioner shall install a Type A screen along the petitioner’s side of the shared property lines of the adjacent residence to the north with an address of 4102 N Lincoln Avenue, Champaign.**
  
- I. No building construction is permitted in proposed Outlot 1.**

The foregoing is an accurate and complete record of the Findings and Determination of the Zoning Board of Appeals of Champaign County.

SIGNED:

ATTEST:

Ryan Elwell, Chair  
Champaign County Zoning Board of Appeals

Secretary to the Zoning Board of Appeals

Date